

JVC



CD RECEIVER
CD-RECEIVER
RECEPTEUR CD
CD-RECEIVER

ENGLISH

DEUTSCH

FRANÇAIS

NEDERLANDS

KD-LH2000R

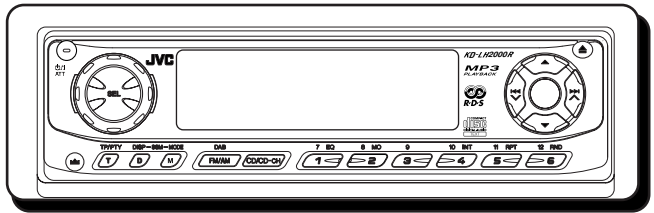
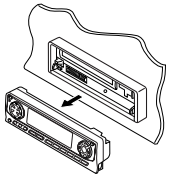

MP3
PLAYBACK

This unit is equipped with the display demonstration. To cancel it, see page 8.
Dieses Gerät ist mit einer Demonstrationsfunktion für das Display ausgestattet. Auf Seite 8 wird beschrieben, wie Sie diese Demonstrationsfunktion deaktivieren können.
Cet appareil est équipé d'une démonstration des affichages. Pour l'annuler, référez-vous à la page 8.
Dit toestel heeft een display-demonstratiefunctie. Zie bladzijde 8 voor het annuleren van deze functie.

For installation and connections, refer to the separate manual.
Für den Einbau und die Anschlüsse siehe das eigenständige Handbuch.
Pour l'installation et les raccordements, se référer au manuel séparé.
Bijzonderheden over de installatie en aansluiting van het apparaat vindt u in de desbetreffende handleiding.

INSTRUCTIONS

BEDIENUNGSANLEITUNG
MANUEL D'INSTRUCTIONS
GEBRUIKSAANWIJZING

LVT0921-001A
[E/EX]

Position And Reproduction Of Labels

Bottom panel of the main unit

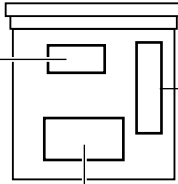

Name/Rating plate

CAUTION: Invisible laser radiation when open and interlock failed or defeated. AVOID DIRECT EXPOSURE TO BEAM.

ADVARSEL: U synlig laserstråling ved åbning, når sikkerhedsafbrydere er ude af funktion. Undgåudsættelse for stråling.

WARNING: O synlig laserstråling når denna del är öppnad och spärren är urkopplad. Betrakta ej strålen.

VARO: Avattaessa ja suojalukitus ohitettaessa olet allittina näkymättömälle lasersäteilylle. Älä katso säteeseen.

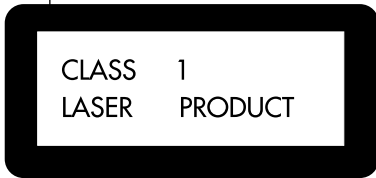

Caution:

This product contains a laser component of higher laser class than Class 1.

IMPORTANT FOR LASER PRODUCTS

Precautions:

- CLASS 1 LASER PRODUCT**
- CAUTION:** Invisible laser radiation when open and interlock failed or defeated. Avoid direct exposure to beam.
- CAUTION:** Do not open the top cover. There are no user-serviceable parts inside. Leave all servicing to qualified service personnel.
- CAUTION:** This CD player uses invisible laser radiation and is equipped with safety switches to prevent radiation emission when unloading CDs. It is dangerous to defeat the safety switches.
- CAUTION:** Use of controls, adjustments or performance of procedures other than those specified herein may result in hazardous radiation exposure.

How to reset your unit

After detaching the control panel, press the reset button on the panel holder using a ball-point pen or similar tool. This will reset the built-in microcomputer.

Note:

Your preset adjustments—such as preset channels or sound adjustments—will also be erased.

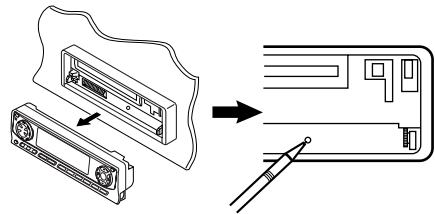

How to use the MODE (M) button:

If you press MODE (M), the unit goes into functions mode and the number buttons work as different function buttons.



To use these buttons as number buttons again after pressing MODE (M), wait for 5 seconds without pressing any number button until the functions mode is cleared.

- Pressing MODE (M) again also clears the functions mode.

Thank you for purchasing a JVC product. Please read all instructions carefully before operation, to ensure your complete understanding and to obtain the best possible performance from the unit.

CONTENTS

How to reset your unit	2	Selecting a directory	27
How to use the MODE (M) button	2	Selecting MP3 playback modes	28
LOCATION OF THE BUTTONS	4	Changing the display pattern	30
Control panel	4	SOUND ADJUSTMENTS	31
Remote controller	5	Adjusting the sound	31
Preparing the remote controller	6	Selecting preset sound modes (iEQ: i-equalizer)	32
BASIC OPERATIONS	7	Storing your own sound adjustments	32
Turning on the power	7	Activating the level meter	34
Changing the display pattern	8	OTHER MAIN FUNCTIONS	35
Canceling the display demonstration	8	Changing the general settings (PSM)	35
RADIO OPERATIONS	9	Changing the display color	39
Listening to the radio	9	Assigning names to the sources	42
Storing stations in memory	11	Detaching the control panel	43
Tuning in to a preset station	12	CD CHANGER OPERATIONS	44
Changing the display pattern	13	Playing CDs	44
RDS OPERATIONS	14	Locating a track or a particular portion on a CD	45
What you can do with RDS	14	Selecting a disc	45
Other convenient RDS functions and adjustments	18	Selecting CD playback modes	46
CD OPERATIONS	20	EXTERNAL COMPONENT OPERATIONS ...	48
Playing a CD	20	Playing an external component	48
Locating a track or a particular portion on a CD	21	DAB TUNER OPERATIONS	49
Selecting CD playback modes	21	Tuning in to an ensemble and one of the services	49
Prohibiting CD ejection	22	Storing DAB services in memory	50
Changing the display pattern	23	Tuning in to a preset DAB service	51
MP3 INTRODUCTION	24	What you can do more with DAB	52
What is MP3?	24	Changing the display pattern	53
How are MP3 files recorded and played back?	24	TROUBLESHOOTING	54
MP3 OPERATIONS	26	MAINTENANCE	56
Playing an MP3 disc	26	Handling discs	56
Locating a file or particular portion on an MP3 disc	27	SPECIFICATIONS	57

CAUTION:

If the temperature inside the car is below 0°C, the movement of source animation and text scroll will be halted on the display to prevent the display from being blurred. When the temperature increases, and the operating temperature is resumed, these functions will start working again.

Note:

For security reasons, a numbered ID card is provided with this unit, and the same ID number is imprinted on the unit's chassis. Keep the card in a safe place, as it will help the authorities to identify your unit if stolen.

BEFORE USE

***For safety...**

- Do not raise the volume level too much, as this will block outside sounds, making driving dangerous.
- Stop the car before performing any complicated operations.

***Temperature inside the car...**

If you have parked the car for a long time in hot or cold weather, wait until the temperature in the car becomes normal before operating the unit.



LOCATION OF THE BUTTONS

ENGLISH

Control panel

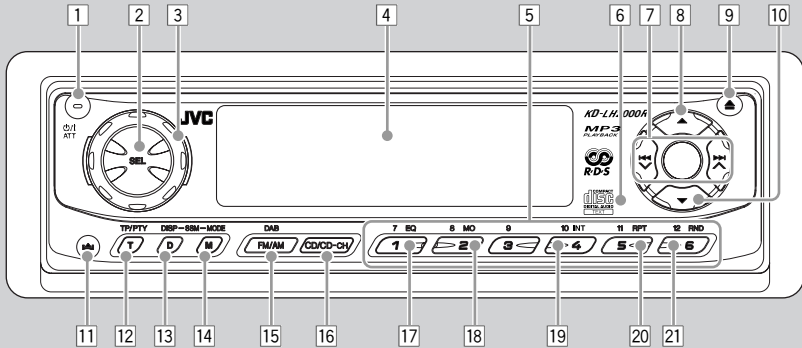

- 1 ATT (standby/on/attenuator) button
- 2 SEL (select) button
- 3 Control dial
- 4 Display window
- 5 Number buttons
- 6 Remote sensor
- 7 buttons
- 8 (up) button
- 9 (eject) button
- 10 (down) button
- 11 (control panel release) button
- 12 TP/PTY (T) (traffic programme/programme type) button
- 13 DISP (D) (display) button
 - Also functions as SSM buttons when pressed together with MODE (M) button.
- 14 MODE (M) button
 - Also functions as SSM buttons when pressed together with DISP (D) (display) button.
- 15 FM/AM DAB button
- 16 CD/CD-CH button
- 17 EQ (equalizer) button
- 18 MO (monaural) button
- 19 INT (intro) button
- 20 RPT (repeat) button
- 21 RND (random) button



Remote controller

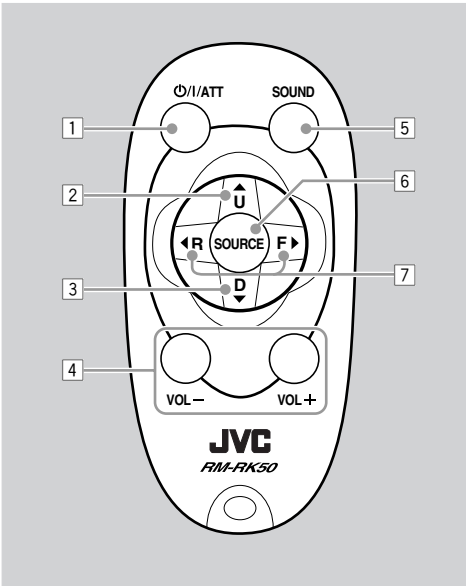

- 1 • Turns on the unit if pressed when the unit is turned off.
 - Turns off the unit if pressed and held for a few seconds.
 - Drops the volume level in a moment if pressed briefly. Press again to resume the volume.
- 2 • Selects the band while listening to the radio (or the DAB tuner). Each time you press the button, the band changes.
 - Skips to the next disc while listening to the CD changer. Each time you press the button, the disc number increases, and the selected disc starts playing.
 - Skips to the first file of the next directory while listening to an MP3 disc. Each time you press the button, you can move to the next directory and start playing the first file.
- 3 • Selects the preset stations while listening to the radio (or the DAB tuner). Each time you press the button, the preset station (or service) number increases, and the selected station (or service) is tuned in.
 - Skips to the previous disc while listening to the CD changer. Each time you press the button, the disc number decreases, and the selected disc starts playing.
 - Skips to the first file of the previous directory while listening to an MP3 disc. Each time you press the button, you can move to the previous directory and start playing the first file.
- 4 Functions the same as the control dial on the main unit.

NOTE: These buttons do not function for the preferred setting mode adjustment.
- 5 Selects the sound (iEQ) mode. Each time you press the button, the sound (iEQ) mode changes.
- 6 Selects the source. Each time you press the button, the source changes.
- 7 • Searches for stations while listening to the radio.
 - Selects services while listening to the DAB tuner if pressed briefly.
 - Searches for ensembles while listening to the DAB tuner if pressed for more than 1 second.
 - Fast-forwards or reverses the track/file if pressed and held while listening to a disc.
 - Skips to the beginning of the next track/file or goes back to the beginning of the current (or previous) tracks/files if pressed briefly while listening to a disc.



Preparing the remote controller

Before using the remote controller:

- Aim the remote controller directly at the remote sensor on the main unit. Make sure there is no obstacle in between.

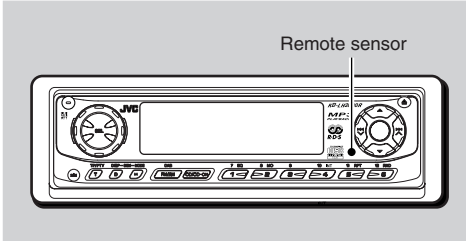

- Do not expose the remote sensor to strong light (direct sunlight or artificial lighting).

Installing the battery

When the controllable range or effectiveness of the remote controller decreases, replace the battery.

1. Remove the battery holder.

- 1) Push out the battery holder in the direction indicated by the arrow using a ball-point pen or a similar tool.
- 2) Remove the battery holder.

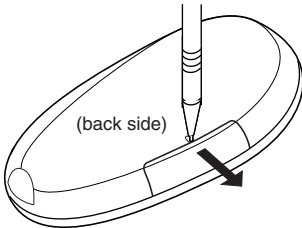

2. Place the battery.

Slide the battery into the holder with the + side facing upwards so that the battery is fixed in the holder.

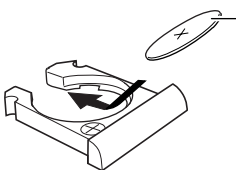

Lithium coin battery
(product number:
CR2025)

3. Return the battery holder.

Insert again the battery holder pushing it until you hear a clicking sound.

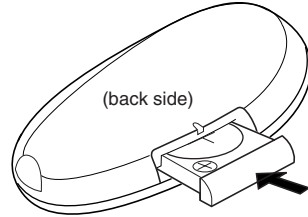

WARNING:

- Store the battery in a place where children cannot reach.
If a child accidentally swallows the battery, consult a doctor immediately.
- Do not recharge, short, disassemble or heat the battery or dispose of it in a fire.
Doing any of these things may cause the battery to give off heat, crack or start a fire.
- Do not leave the battery with other metallic materials.
Doing this may cause the battery to give off heat, crack or start a fire.
- When throwing away or saving the battery, wrap it in tape and insulate; otherwise, the battery may start to give off heat, crack or start a fire.
- Do not poke the battery with tweezers or similar tools.
Doing this may cause the battery to give off heat, crack or start a fire.

CAUTION:

DO NOT leave the remote controller in a place (such as dashboards) exposed to direct sunlight for a long time. Otherwise, it may be damaged.

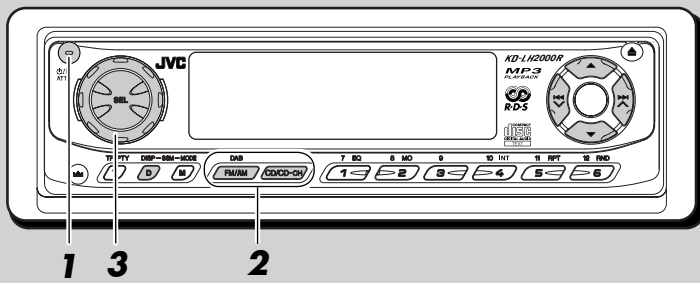

Turning on the power

1 Turn on the power.



Note on One-Touch Operation:

When you select a source in step 2 below, the power automatically comes on. You do not have to press this button to turn on the power.

2 Select the source.

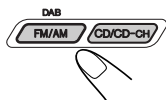

To operate the tuner (FM or AM), see pages 9 – 19.

To play a CD, see pages 20 – 23 .

To play an MP3 disc, see pages 26 – 30.

To operate the CD changer, see pages 44 – 47.

To operate the external component (Line In), see page 48.

To operate the DAB tuner, see pages 49 – 53.

CAUTION on Volume Setting:

Discs produce very little noise compared with other sources. If the volume level is adjusted for the tuner, for example, the speakers may be damaged by the sudden increase in the output level. Therefore, lower the volume before playing a disc and adjust it as required during playback.

3 Adjust the volume.

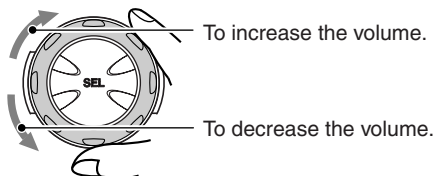

Volume level appears

4 Adjust the sound as you want. (See pages 31 – 34.)

To drop the volume in a moment

Press **CH/ATT** briefly while listening to any source. "ATT" starts flashing on the display, and the volume level will drop in a moment.

To resume the previous volume level, press the button briefly again.

- If you turn the control dial, you can also restore the sound.

To turn off the power

Press **CH/ATT** for more than one second.

- **If you turn off the power while listening to a disc**, CD play will start from where playback has been stopped previously, next time you turn on the power.

Note:

When you use this unit for the first time, set the built-in clock correctly, see page 35.

Changing the display pattern

You can change the display pattern.

The number of the selectable display patterns varies according to the playback sources. However, the unit basically provides three main display patterns for each source, and once one of these three patterns is selected, the same pattern is used for all the sources.

Press DISP (D).



Each time you press the button, the display patterns change as follows:

EX.: When playing a CD

Large animation display

Small animation displays*

Clock time display

* Small animation displays are used for showing not only the source's main information (illustrated on this page as examples), but also showing some other information. For details, see each related section. (For the DAB tuner, small animation display will show no animation.)

In this manual, the illustrations of the display are mainly of the large animation display (initial setting). If you have changed the display patterns or some PSM items, the actual displays you see will be different.

Note:

While playing a source, you can also show the level meter on the display. For details, see "Activating the level meter" on page 34.

Cancelling the display demonstration

When shipped from the factory, display demonstration (MovieDemo) has been activated, and starts automatically when no operations are done for about 20 seconds.

- It is recommended to cancel the demonstration before you use the unit for the first time.

To cancel the display demonstration, follow the procedure below:

- 1 Press and hold SEL (select) for more than 2 seconds so that "MovieDemo" appears on the display. (see pages 36 and 37.)

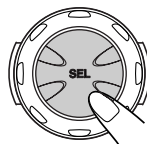

- 2 Select "Off."

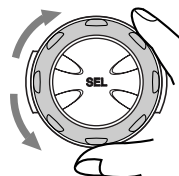

- 3 Press SEL (select) to finish the setting.

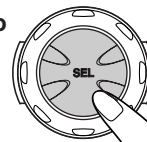

To activate the display demonstration, repeat the same procedure and select "Interval" or "All Time" in step 2.

- For more details, see "To set the movie demo—MovieDemo" on page 37.

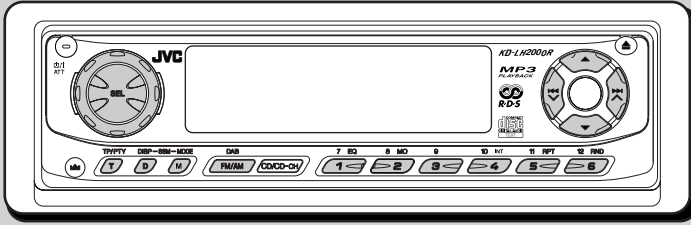

Listening to the radio

You can use either automatic searching or manual searching to tune in to a particular station.

Searching for a station automatically: Auto search

1 Select the band (FM1 – 3, AM).

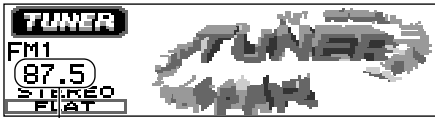
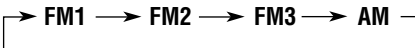

Last received station of the selected band is tuned in.

Note:

This receiver has three FM bands (FM1, FM2, FM3). You can use any one of them to listen to an FM broadcast.

2 Start searching for a station.

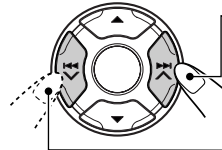

Press ►►▲ to search for stations of higher frequencies.

Press ◀◀▼ to search for stations of lower frequencies.

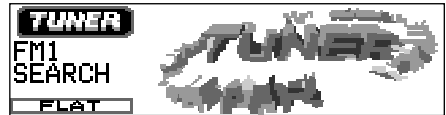

Ex.: When the band is FM

When a station is received, searching stops.

To stop searching before a station is received, press the same button you have pressed for searching.



Searching for a station manually: Manual search

1 Select the band (FM1 – 3, AM).

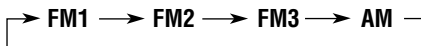
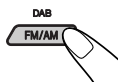

Note:

This receiver has three FM bands (FM1, FM2, FM3). You can use any one of them to listen to an FM broadcast.

2 Press and hold **▶▶|▲** or **◀◀|▼** until “Manual Search” starts flashing on the display.



3 Tune in to a station you want while “Manual Search” is flashing.

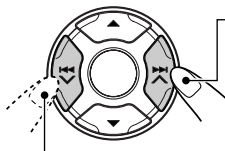

Press **▶▶|▲** to tune in to stations of higher frequencies.

Press **◀◀|▼** to tune in to stations of lower frequencies.

- If you release your finger from the button, the manual mode will automatically turn off after 5 seconds.
- If you hold down the button, the frequency keeps changing (in 50 kHz intervals for FM and 9 kHz intervals for AM—MW/LW) until you release the button.

When an FM stereo broadcast is hard to receive:



1 Press MODE (M) to enter the functions mode while listening to an FM stereo broadcast. “Mode” appears on the display.

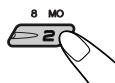

2 Press MO (monaural), while “Mode” is still on the display, so that the MO indicator is highlighted on the display. Each time you press MO, “Mono On” and “Mono Off” alternately appears.



MONO indicator

MO indicator

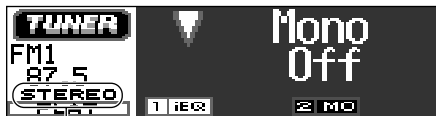

“STEREO” is lit when receiving an FM broadcast in stereo.

When the MONO indicator is lit on the display, the sound you hear becomes monaural but the reception will be improved.

If the sound quality decreases and the stereo effect is lost while listening to an FM station

In some areas, adjacent stations may interfere with each other. If this interference occurs, this unit can automatically reduce this interference noise (the initial setting when shipped from the factory). However, in this case, the sound quality will be degraded and the stereo effect will be also lost.

If you do not want to degrade the sound quality and to lose the stereo effect, rather than to eliminate the interference noise, see “To change the FM tuner selectivity—IF Filter” on page 38.

Storing stations in memory

You can use one of the following two methods to store broadcasting stations in memory.

- Automatic preset of FM stations: SSM (Strong-station Sequential Memory)
- Manual preset of both FM and AM stations

FM station automatic preset: SSM

You can preset 6 local FM stations in each FM band (FM1, FM2 and FM3).

- 1 Select the FM band (FM1 – 3) you want to store FM stations into.**

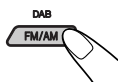

Each time you press the button, the band changes as follows:

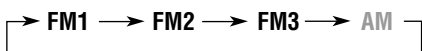

- 2 Press and hold both buttons for more than 2 seconds.**

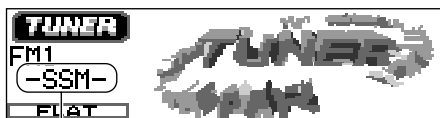
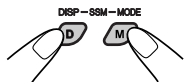

“-SSM-” appears, then disappears when automatic preset is over.

Local FM stations with the strongest signals are searched and stored automatically in the band number you have selected (FM1, FM2 or FM3). These stations are preset in the number buttons — No.1 (lowest frequency) to No.6 (highest frequency). When automatic preset is over, the station stored in number button 1 will be automatically tuned in.

Manual preset

You can preset up to 6 stations in each band (FM1, FM2, FM3 and AM) manually.

Ex.: Storing an FM station of 88.3 MHz into the preset number 1 of the FM1 band.

- 1 Select the band (FM1 – 3, AM) you want to store stations into (in this example, FM1).**

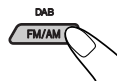

Each time you press the button, the band changes as follows:

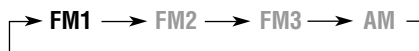

- 2 Tune in to a station (in this example, of 88.3 MHz).**

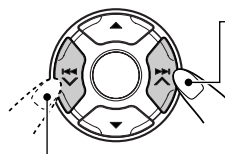

Press ►► ▲ to tune in to stations of higher frequencies.

Press ◀◀ ▼ to tune in to stations of lower frequencies.

- 3 Press and hold the number button (in this example, 1) for more than 2 seconds.**

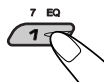

The display pattern automatically changes to the small animation display and the preset number flashes (then the previous display pattern resumes).

CONTINUED ON THE NEXT PAGE



4 Repeat the above procedure to store other stations into other preset numbers.

Note:

A previously preset station is erased when a new station is stored in the same preset number.

Tuning in to a preset station

You can easily tune in to a preset station. Remember that you must store stations first. If you have not stored them yet, see "Storing stations in memory" on page 11.

Selecting a preset station directly

1 Select the band (FM1 – 3, AM).

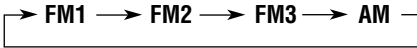

2 Select the number (1 – 6) for the preset station you want.

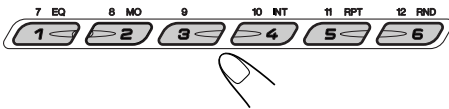

Selecting a preset station using the preset station list

If you forget what stations are stored in what preset numbers, you can check the preset station list, then select your desired station on the list.

1 Select the band (FM1 – 3, AM).

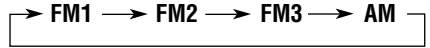
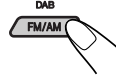

2 Press and hold **▲** (up) or **▼** (down) until the preset station list for the current band (FM1, FM2, FM3, or AM) appears on the display.

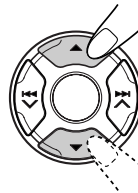

Notes:

- If one of FM band preset station lists (FM1, FM2, or FM3) is shown on the display, you can show the other lists by pressing **▲** or **▼**.
- If a preset station is an FM RDS station with PS signal, PS name will be shown instead of the station frequency.

3 Select the number (1 – 6) for the preset station you want.

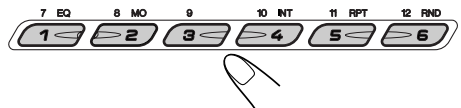

Changing the display pattern

By pressing DISP (D), you can change the information shown on the display.



Each time you press the button, the display patterns change as follows:

- When receiving an AM or FM non-RDS station

Large animation display

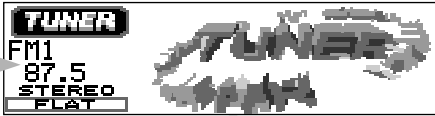

Small animation display



Clock time display



- When receiving an FM RDS station (see the following pages)

Large animation display

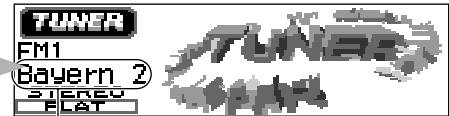

PS name

Small animation displays



PTY code appears



Clock time display





RDS OPERATIONS

What you can do with RDS

RDS (Radio Data System) allows FM stations to send an additional signal along with their regular programme signals. For example, the stations send their station names, as well as information about what type of programme they broadcast, such as sports or music, etc.

Another advantage of RDS function is called "Enhanced Other Networks." By using the Enhanced Other Networks data sent from a station, you can tune in to a different station of a different network broadcasting your favourite programme or traffic announcement while listening to another programme or to another source such as CD.

By receiving the RDS data, this unit can do the following:

- Tracing the same programme automatically (Network-Tracking Reception)
- Standby Reception of TA (Traffic Announcement) or your favourite programme
- PTY (Programme Type) search
- Programme search
- And some other functions

Tracing the same programme automatically (Network-Tracking Reception)

When driving in an area where FM reception is not good, the tuner built in this unit automatically tunes in to another RDS station, broadcasting the same programme with stronger signals. So, you can continue to listen to the same programme in its finest reception, no matter where you drive. Two types of the RDS data are used to make Network-Tracking Reception work correctly—PI (Programme Identification) and AF (Alternative Frequency).

Without receiving these data correctly from the RDS station you are listening to, Network-Tracking Reception will not operate.

The same programme can be received on different frequencies.

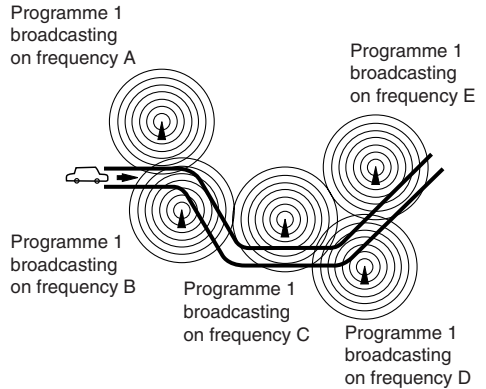

To use Network-Tracking Reception

You can select the different modes of network-tracking reception to continue listening to the same programme in its finest reception. When shipped from the factory, "AF" is selected.

- **AF:** Network-Tracking Reception is activated with Regionalization set to "off." With this setting, the unit switches to another station within the same network when the receiving signals from the current station become weak. (In this mode, the programme may differ from the one currently received.) The AF indicator lights up but the REG indicator does not.
- **AF Reg:** Network-Tracking Reception is activated with Regionalization set to "on." With this setting, the unit switches to another station, within the same network, broadcasting the same programme when the receiving signals from the current station become weak. Both the AF indicator and the REG indicator light up.
- **Off:** Network-Tracking Reception is deactivated. Neither the AF indicator nor the REG indicator lights up.



AF indicator REG indicator

Using TA Standby Reception

TA Standby Reception allows the unit to switch temporarily to Traffic Announcement (TA) from the current source (another FM station or CD and other connected components).

- TA Standby Reception will not work if you are listening to an AM station.

Note:

If a DAB tuner is connected and Alternative Reception (for DAB services) is activated, Network-Tracking Reception is also activated (“AF”) automatically. On the other hand, Network-Tracking Reception cannot be deactivated without deactivating Alternative Reception. (See page 52.)



TP indicator

- 1 Press and hold SEL (select) for more than 2 seconds so that one of the PSM items appears on the display. (PSM: see pages 36 and 37.)



Press TP/PTY (T) to activate TA Standby Reception.

- When the current source is FM, the TP indicator either lights up or flashes.

- If the TP indicator lights up, TA Standby Reception is activated.

If a station starts broadcasting a traffic announcement, “Traffic Flash” appears on the display, and this unit automatically tunes in to the station. The volume changes to the preset TA volume level (see page 18) and the traffic announcement can be heard.

- If the TP indicator flashes, TA Standby Reception is not yet activated since the station being received does not provide the signals used for TA Standby Reception. To activate TA Standby Reception, you need to tune in to another station providing these signals. Press ►► ▲ or ◀◀ ▼ to search for such a station.

When a station providing these signals is tuned in, the TP indicator stops flashing and remains lit. Now TA Standby Reception is activated.

- When the current source is other than FM, the TP indicator lights up.

If a station starts broadcasting a traffic announcement, “Traffic Flash” appears on the display, and this unit automatically changes the source and tunes in to the station.

To deactivate the TA Standby Reception, press TP/PTY (T) again.

- 2 Press ▲ (up) or ▼ (down) repeatedly until “Tuner” is selected as the PSM category (it is shown on the left side of the display).



- 3 Select “AF-Regn’ (alternative frequency/ regionalization reception).”



- 4 Select the desired mode—“AF,” “AF Reg” or “Off.”



- 5 Finish the setting.





Using PTY Standby Reception

PTY Standby Reception allows the unit to switch temporarily to your favourite programme (PTY: Programme Type) from the current source (another FM station, CD or other connected components).

- *PTY Standby Reception will not work if you are listening to an AM station.*

You can select your favourite programme type for PTY Standby Reception.

When shipped from the factory, PTY Standby Reception is turned off. ("Off" is selected for PTY Standby Reception.)

- 1** Press and hold SEL (select) for more than 2 seconds so that one of the PSM items appears on the display.
- (PSM: see pages 36 and 37.)



- 2** Press ▲ (up) or ▼ (down) repeatedly until "Tuner" is selected as the PSM category (it is shown on the left side of the display).



- 3** Select "PTY Stnby (standby)."



- 4** Select one of the twenty-nine PTY codes.
- (See page 19.)

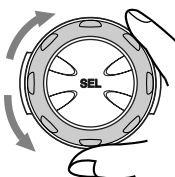

Selected code name appears on the display and is stored into memory.

5 Finish the setting.



PTY indicator

- **When the current source is FM**, the PTY indicator either lights up or flashes.

- If the PTY indicator lights up, PTY Standby Reception is activated. If a station starts broadcasting the selected PTY programme, this unit automatically tunes in to the station.

- If the PTY indicator flashes, PTY Standby Reception is not yet activated since the station being received does not provide the signals used for PTY Standby Reception.

To activate PTY Standby Reception, you need to tune in to another station providing these signals. Press ►► ▲ or ◀◀ ▼ to search for such a station. When a station providing these signals is tuned in, the PTY indicator stops flashing and remains lit. Now PTY Standby Reception is activated.

- **When the current source is other than FM**, the PTY indicator lights up.

If a station starts broadcasting the selected PTY programme, this unit automatically changes the source and tunes in to the station.

To deactivate the PTY Standby Reception, select "Off" in step 4 by turning the control dial. The PTY indicator disappears.



Searching for your favorite programme

You can search for any one of the PTY codes. In addition, you can store your 6 favourite programme types in the number buttons. When shipped from the factory, the following 6 programme types have been stored in the number buttons (1 to 6).

1	2	3
POP M	Rock M	Easy M
4	5	6
Classics	Affairs	Varied

To search for your favorite programme type

- 1 Press and hold TP/PTY (T) for more than 2 seconds while listening to an FM station.



The last selected PTY code appears.

To store your favorite programme types

- 1 Press and hold TP/PTY (T) for more than 2 seconds while listening to an FM station.



The last selected PTY code appears.

- 2 Select one of the twenty-nine PTY codes. (See page 19.)

Selected code name appears on the display.



- 2 Select one of the PTY codes.

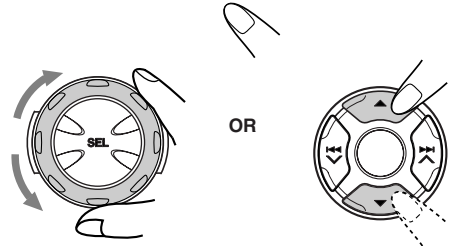

Ex.: When "ROCK M" is selected

- 3 Press and hold the number button for more than 2 seconds to store the PTY code selected into the preset number you want.



Preset number flashes for a while, and the selected PTY code is stored into the preset number.

- 4 Press and hold TP/PTY (T) for more than 2 seconds.



How to use the ▲ (up) or ▼ (down) button

By pressing ▲ or ▼ repeatedly, you can show the list of your preset PTY codes and all twenty-nine PTY codes (six PTY codes at a time). First, the list of your stored PTY codes appears, then all twenty-nine PTY codes (six PTY codes at a time) appears in sequence. Press the number button to select your desired PTY code on the list currently shown on the display.

CONTINUED ON THE NEXT PAGE



- 3** Start PTY search for your favorite programme.



- If there is a station broadcasting a programme of the same PTY code as you selected, that station is tuned in.
- If there is no station broadcasting a programme of the same PTY code as you selected, the station will not change.

Note:

In some areas, the PTY search will not work correctly.

Other convenient RDS functions and adjustments

Setting the TA volume level

You can preset the volume level for TA Standby Reception. When a traffic programme is received, the volume level automatically changes to the preset level.

- See also “Changing the general settings (PSM)” on page 35.
- 1 Press and hold SEL (select) for more than 2 seconds so that one of the PSM items appears on the display.
 - 2 Press ▲ (up) or ▼ (down) repeatedly until “Tuner” is selected as the PSM category (it is shown on the left side of the display).
 - 3 Press ►►| ▲ or |◄◄ ▼ to select “TA Volume.”
 - 4 Turn the control dial to set to the desired volume. You can set it from “Volume 0” to “Volume 50.”
 - 5 Press SEL (select) to finish the setting.

Automatic selection of the station when using the number buttons

Usually when you press the number button, the preset station is tuned in.

However, when the preset station is an RDS station, something different will happen. If the signals from that preset station are not sufficient for good reception, this unit, using the AF data, tunes in to another frequency broadcasting the same programme as the original preset station is broadcasting. (Programme search)

- The unit takes some time to tune in to another station using Programme search.

To activate programme search, follow the procedure below.

- See also “Changing the general settings (PSM)” on page 35.

- 1 Press and hold SEL (select) for more than 2 seconds so that one of the PSM items appears on the display.
- 2 Press ▲ (up) or ▼ (down) repeatedly until “Tuner” is selected as the PSM category (it is shown on the left side of the display).
- 3 Press ►►| ▲ or |◄◄ ▼ to select “P(Programme)-Search.”
- 4 Turn the control dial clockwise to select “On.” Now programme search is activated.
- 5 Press SEL (select) to finish the setting.

To cancel programme search, repeat the same procedure and select “Off” in step 4 by turning the control dial counterclockwise.



Automatic clock adjustment

When shipped from the factory, the clock built in this unit is set to be readjusted automatically using the CT (Clock Time) data in the RDS signal.

If you do not want to use automatic clock adjustment, follow the procedure below.

- See also “Changing the general settings (PSM)” on page 35.

- 1 Press and hold SEL (select) for more than 2 seconds so that one of the PSM items appears on the display.
- 2 Press ▲ (up) or ▼ (down) repeatedly until “Clock” is selected as the PSM category (it is shown on the left side of the display).
- 3 Press ►►| ▲ or |◄◄ ▼ to select “Auto Adj (adjustment).”
- 4 Turn the control dial counterclockwise to select “Off.”
Now automatic clock adjustment is canceled.
- 5 Press SEL (select) to finish the setting.

To reactivate clock adjustment, repeat the same procedure and select “On” in step 4 by turning the control dial clockwise.

Note:

You must stay tuned to the same station for more than 2 minutes after setting “Auto Adj” to “On.” Otherwise, the clock time will not be adjusted. (This is because the unit takes up to 2 minutes to capture the CT data in the RDS signal.)

PTY codes

News:	News	Social:	Programmes on social activities
Affairs:	Topical programmes expanding on current news or affairs	Religion:	Programmes dealing with any aspect of belief or faith, or the nature of existence or ethics
Info:	Programmes which impart advice on a wide variety of topics	Phone In:	Programmes where people can express their views either by phone or in a public forum
Sport:	Sport events	Travel:	Programmes about travel destinations, package tours, and travel ideas and opportunities
Educate:	Educational programmes	Leisure:	Programmes concerned with recreational activities such as gardening, cooking, fishing, etc.
Drama:	Radio plays	Jazz:	Jazz music
Culture:	Programmes on national or regional culture	Country:	Country music
Science:	Programmes on natural science and technology	Nation M:	Current popular music from another nation or region, in that country's language
Varied:	Other programmes like comedies or ceremonies	Oldies:	Classic pop music
POP M:	Pop music	Folk M:	Folk music
Rock M:	Rock music	Document:	Programmes dealing with factual matters, presented in an investigative style
Easy M:	Easy-listening music		
Light M:	Light music		
Classics:	Classical music		
Other M:	Other music		
Weather:	Weather information		
Finance:	Reports on commerce, trading, the Stock Market, etc.		
Children:	Entertainment programmes for children		



CD OPERATIONS

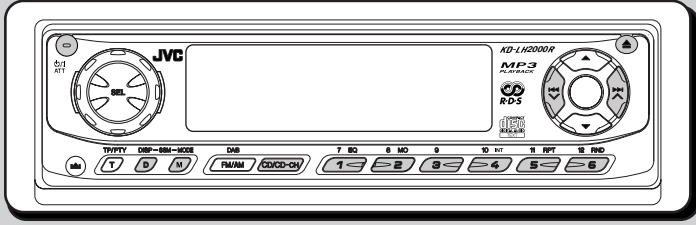

Playing a CD

1 Open the control panel.

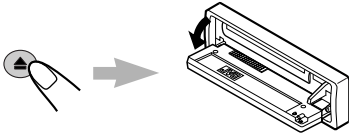

2 Insert a disc into the loading slot.

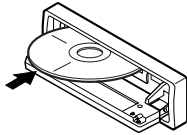

The unit turns on, draws a disc and starts playback automatically.

3 Close the control panel by hand.

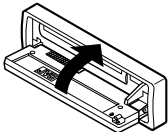

The opening display then source name display appears first....

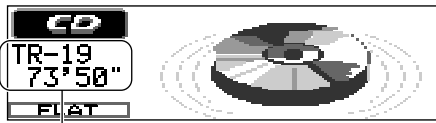

Total track number/Total playing time

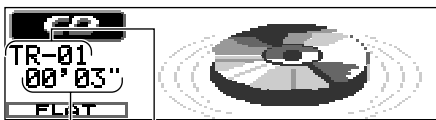

Current track
Elapsed playing time

All tracks will be played repeatedly until you stop playback.

Notes:

- When a disc is already in the loading slot, selecting "CD" as the source starts CD play.
- When a disc is inserted upside down, the disc automatically ejects (if the control panel is open). If the control panel is closed, "Please Eject" appears.
- If you change the source, CD play also stops (without ejecting the disc).
Next time you select "CD" as the source, CD play starts from where playback has been stopped previously.

To stop play and eject the disc

Press ▲.

CD play stops, the control panel opens, then the disc automatically ejects from the loading slot. If you change the source, the CD play also stops (without ejecting the disc this time).

Notes:

- If the ejected disc is not removed for about 15 seconds, the disc is automatically inserted again into the loading slot to protect it from dust. (CD play will not start this time.)
- You can eject the disc even when the unit is turned off.



Locating a track or a particular portion on a CD

To fast-forward or reverse the track

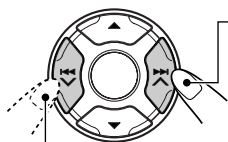

Press and hold **▶▶▶ ▲**, while playing a disc, to fast-forward the track.

Press and hold **◀◀◀ ▼**, while playing a disc, to reverse the track.

To go to the next or previous tracks

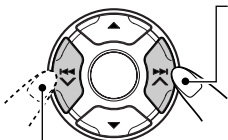

Press **▶▶▶ ▲** briefly, while playing a disc, to go ahead to the beginning of the next track. Each time you press the button consecutively, the beginning of the next tracks is located and played back.

Press **◀◀◀ ▼** briefly, while playing a disc, to go back to the beginning of the current track. Each time you press the button consecutively, the beginning of the previous tracks is located and played back.

To go to a particular track directly

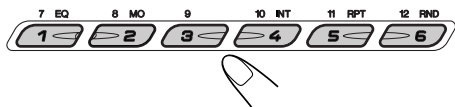

Press the number button corresponding to the track number to start its playback.

- To select a track number from 1 – 6:
Press 1 (7) – 6 (12) briefly.
- To select a track number from 7 – 12:
Press and hold 1 (7) – 6 (12) for more than 1 second.

Selecting CD playback modes

To play back tracks at random (Random Play)

You can play back all tracks on the disc at random.



- Press **MODE (M)** to enter the functions mode while playing a disc. "Mode" appears on the display.



- Press **RND (random)**, while "Mode" is still on the display, so that the RND indicator is highlighted on the display. Each time you press RND, "Random On" or "Random Off" alternately appears.



RANDOM indicator

RND indicator is highlighted when "Random On" is selected.

When Random Play is turned on, the RANDOM indicator lights up on the display and a track randomly selected starts playing.



To play back tracks repeatedly (Repeat Play)

You can play back the current track repeatedly.



- 1 Press MODE (M) to enter the functions mode while playing a disc. "Mode" appears on the display.

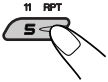

- 2 Press RPT (repeat), while "Mode" is still on the display, so that the RPT indicator is highlighted on the display. Each time you press RPT, "Repeat On" or "Repeat Off" alternately appears.



REPEAT indicator

RPT indicator is highlighted when "Repeat On" is selected.

When Repeat Play is turned on, the REPEAT indicator lights up on the display.

To play back only intros (Intro Scan)

You can play back the first 15 seconds of each track sequentially.



- 1 Press MODE (M) to enter the functions mode while playing a disc. "Mode" appears on the display.

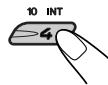

- 2 Press INT (intro), while "Mode" is still on the display, so that the INT indicator is highlighted on the display. Each time you press INT, "Intro On" or "Intro Off" alternately appears.

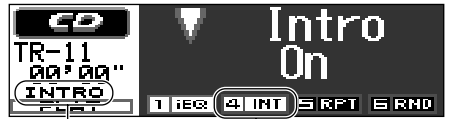

INTRO indicator

INT indicator is highlighted when "Intro On" is selected.

When Intro Scan is turned on, the INTRO indicator lights up on the display.

Prohibiting CD ejection

You can prohibit CD ejection and can lock a disc in the loading slot.

While pressing CD/CD-CH, press and hold ϕ /I ATT for more than 2 seconds.



"No Eject" flashes on the display for about 5 seconds, and the disc is locked and cannot be ejected.

To cancel the prohibition and unlock the disc, press ϕ /I ATT again for more than 2 seconds, while pressing CD/CD-CH.

"Eject OK" flashes on the display for about 5 seconds, and the disc is unlocked.



Changing the display pattern

By pressing DISP (D), you can change the information shown on the display.



Each time you press the button, the display patterns change as follows:

Large animation display

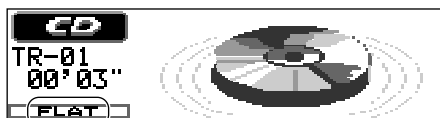

iEQ mode
(see page 32)

Small animation display 1

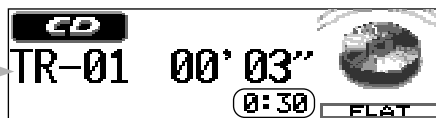

Small animation display 2



Small animation display 3

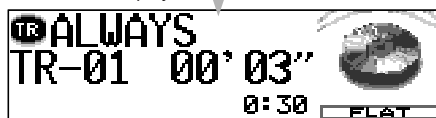

Small animation display 4



Clock time display



Notes:

- When the disc title/performer is shown, the DISC indicator lights up. When the track title is shown, the TR indicator lights up.
- If the information cannot be shown at a time, it will scroll on the display.
Some characters or symbols will not be shown (will be blanked or substituted) on the display.
- If no name is assigned to the audio CD, "NO NAME" will appear.
To assign a name to a conventional CD, see page 42.
- If no disc title/performer or no track title is recorded for the CD Text, "NO NAME" will appear.



MP3 INTRODUCTION

What is MP3?

MP3 is an abbreviation of Motion Picture Experts Group (or MPEG) Audio Layer 3. MP3 is simply a file format with a data compression ratio of 1:10 (128 Kbps*). That means, by using MP3 format, one CD-R or CD-RW can contain 10 times as much data volume as a regular CD can.

* Bit rate is the average number of bits that one second of audio data will consume. The unit used is Kbps (1000 bits/second). To get a better audio quality, choose a higher bit rate. The most popular bit rate for encoding is 128 Kbps.

This unit is incorporated with an MP3 decoder. You can play back MP3 files (tracks) recorded on CD-Rs, CD-RWs, and CD-ROMs.

Compatible with ID3v1

Extra information data such as album title, performer name, song title, recording year, music genre and a brief comment can be stored within an MP3 file.

This unit can show ID3v1 tags (album name, performer name and song title) on the display. (See page 57.)

- Some characters cannot be shown correctly.
- This unit is not compatible with ID3v2.

Other Main Features in this unit:

- Maximum number of directories/files: 289 (Total)
- Available characters for directory/file names: A–Z, 0–9, _ (underscore)
- Maximum number of characters for file name (ISO 9660 Level 1): 12 (inclusive of separation mark—“.” and extension code—“mp3”)
- (ISO 9660 Level 2): 31 (inclusive of separation mark—“.” and extension code—“mp3”)
- (Joliet): 64 (inclusive of separation mark—“.” and extension code—“mp3”)
- Maximum number of characters for directory name: 64

Precautions when recording MP3 files on a CD-R or CD-RW

This unit can only read MP3 files that are recorded in the format that is compliant with ISO 9660 Level 1, Level 2 or Joliet.

How are MP3 files recorded and played back?

MP3 “files (tracks)” can be recorded in “directories (folders)”—in PC terminology. During recording, the files and directories can be arranged in a way similar to arranging files and directories/folders of computer data.

“Root” is similar to the root of a tree. Every file and directory can be linked to and be accessed from the root.

Playback order, file search order, and directory search order of the MP3 files recorded on a disc are determined by the writing (or encoding) application; therefore, playback order may be different from the one you have intended while recording the directories and the files.

The illustration on the next page shows an example of how MP3 files are recorded on a CD-R or CD-RW, how they are played back, and how they are searched for on this unit.



Notes:

- The unit can read a CD-ROM containing MP3 files. However, if non-MP3 files are recorded together with MP3 files, this unit will take a longer time to scan the disc. It may also cause the unit to malfunction.
- The unit cannot read or play an MP3 file without the extension code—mp3.
- This player is not compatible with the data encoded with Layer1 and Layer 2 formats.
- The unit is not compatible with Playlist**.

** A playlist is a simple text file, used on a PC, which enables users to make their own playback order without physically rearranging the files.

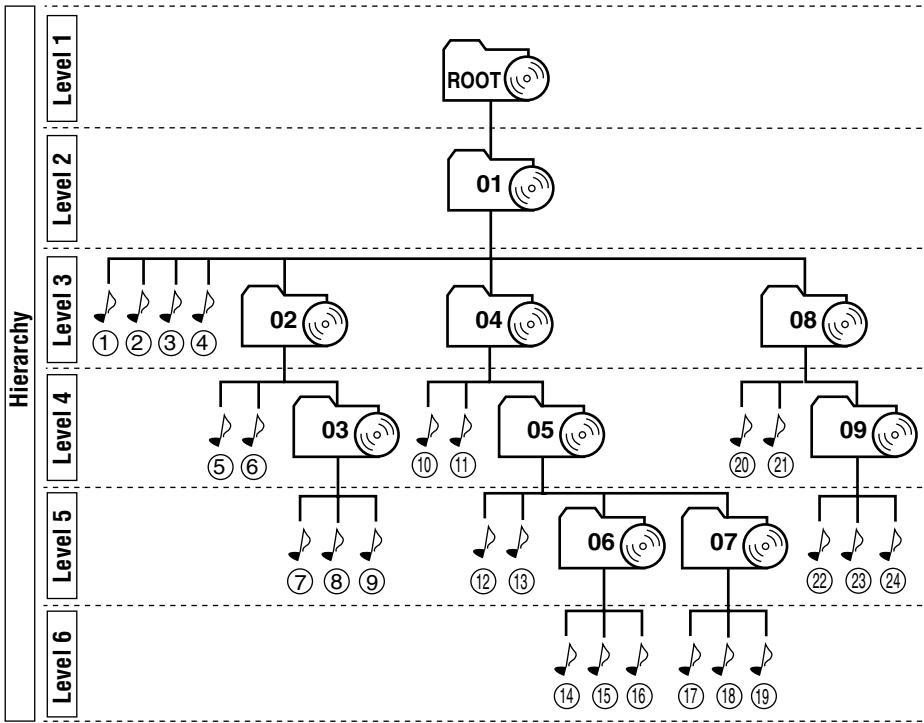
MP3 directory/file configuration



	: Root
	: Directories
	: MP3 files

Note:
 There is no limit on the number of the hierarchy levels (nested directories). However, it is recommended to limit the numbers of hierarchy levels up to 8 for stable operations.

MP3 playback/search order

- The numbers in circles below the MP3 files () indicate the playback order and search order of the MP3 files. Normally this unit plays back MP3 files in the recorded order.
- The numbers inside the directories indicate the playback order and search order of the directories on an MP3 disc. Normally this unit plays back MP3 files in the directories in the recorded order.

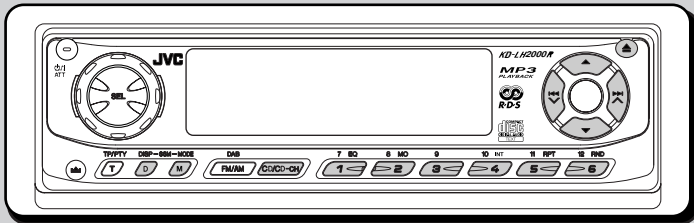

Refer also to “CD OPERATIONS” on pages 20 to 23.

The display changes to show the following:

Playing an MP3 disc

1 Open the control panel.

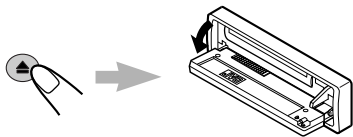

2 Insert an MP3 disc into the loading slot.

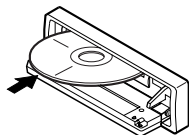

The unit draws the disc. Playback starts automatically from the first file of the first directory once disc check is completed.

3 Close the control panel by hand.

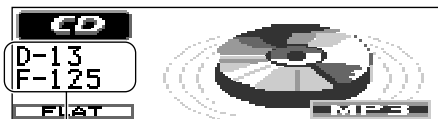
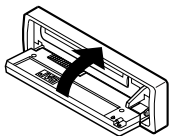

EX.:When the disc contains 13 directories and 125 MP3 files.

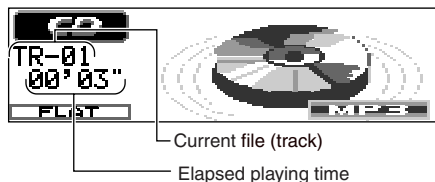

All the files (tracks) on the disc will be played repeatedly until you stop playback.

Notes:

- MP3 discs require a longer readout time. (It differs due to the complexity of the directory/file configuration.)
- If you change the source or turn the power off, MP3 playback stops (without ejecting the disc). Next time you select disc play as the source or turn the power on, MP3 playback starts from where playback has been stopped previously.

To stop play and eject the disc

Press ▲.

Playback stops, the control panel moves down, and the disc automatically ejects from the loading slot.

Locating a file or particular portion on an MP3 disc

To fast-forward or reverse the file

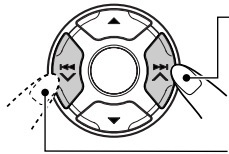

Press and hold ►► ▲ while playing an MP3 disc, to fast-forward the file.

Press and hold ◀◀ ▼ while playing an MP3 disc, to reverse the file.

Note:

During this operation, you can only hear intermittent sounds. (The elapsed playing time also changes intermittently on the display.)

To skip to the next or previous files

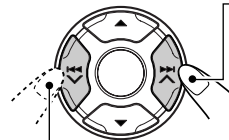

Press ►► ▲ briefly while playing, to skip ahead to the beginning of the next file. Each time you press the button consecutively, the beginning of the next files is located and played back. (See "MP3 playback/search order" on page 25.)

Press ◀◀ ▼ briefly, while playing, to skip back to the beginning of the current file. Each time you press the button consecutively, the beginning of the previous files is located and played back. (See "MP3 playback/search order" on page 25.)

Selecting a directory

You can select a directory or skip to another directory easily.

To go to a particular directory directly

IMPORTANT:

To directly select the directories using the number button(s), it is required that directories are assigned 2 digit numbers at the beginning of their directory names. (This can only be done during the recording of CD-Rs or CD-RWs.)

Ex.: If directory name is "01 ABC"

→ press 1 to go to Directory 01 ABC.
If directory name is "1 ABC,"
pressing 1 does not work.

If directory name is "12 ABC"

→ press and hold 6 (12) to go to
Directory 12 ABC.

Press the number button corresponding to the directory number to start playing the first file in the selected directory.

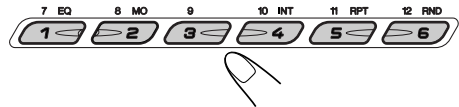

- To select a directory number from 01 – 06:
Press 1 (7) – 6 (12) briefly.
- To select a directory number from 07 – 12:
Press and hold 1 (7) – 6 (12) for more than 1 second.

Notes:

- If "MP3" flashes on the display after you have selected a directory, it means that the directory does not contain any MP3 files.
- You cannot directly select a directory with a number greater than 12.

To select a particular file in a directory, press ►► ▲ or ◀◀ ▼ after selecting the directory.

To skip to the next directory

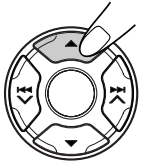

Press ▲ (up) briefly while playing an MP3 disc.
Each time you press the button consecutively, the next directory is located (and the first file in the directory starts playing, if recorded). (See "MP3 playback/search order" on page 25.)

To skip to the previous directory



Press ▼ (down) briefly while playing an MP3 disc.
Each time you press the button consecutively, the previous directory is located (and the first file in the directory starts playing, if recorded). (See "MP3 playback/search order" on page 25.)

Note:

If the directory does not contain any MP3 files, it is skipped.

To select a directory on the list shown on the display

You can show the lists of directory names on the display (six names at a time), and can select a directory on the lists.

- 1 Press and hold ▲ or ▼ so that the first list of the directory names (directory no.1 to no.6) appears on the display.



Note:

When a directory does not contain any MP3 files, it may take time to show the lists.

2 Find a directory you want to play.



Each time you press ▲ or ▼, the directory name lists change.

3 Select the number (1 – 6) for the directory you want.

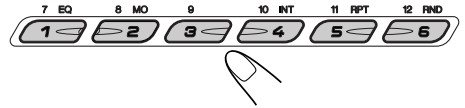

The first file in the selected directory starts playing.

Selecting MP3 playback modes

To play back files at random (Random Play)

You can play back all files on the MP3 disc at random.



- 1 Press MODE (M) to enter the functions mode while playing an MP3 disc.
"Mode" appears on the display.

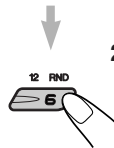

- 2 Press RND (random), while "Mode" is still on the display, so that the RND indicator is highlighted on the display.
Each time you press RND, the random play mode changes as follows:





RANDOM indicator RND indicator
 (See the following table.)
 Ex.: When you select "Random 1."

Mode	RND Indicator	Plays at random
Random 1	Highlighted	All files of the current directory, then the files of the next directory and so on.
Random 2	Flashes	All files on the disc.

When Random Play is turned on, the RANDOM indicator lights up or flashes on the display.

To play back files repeatedly (Repeat Play)

You can play back the current file or all the files in the current directory repeatedly.

- 1 Press MODE (M) to enter the functions mode while playing an MP3 disc.
 "Mode" appears on the display.
- 2 Press RPT (repeat) while "Mode" is still on the display, so that the RPT indicator is highlighted on the display.
 Each time you press RPT, the repeat play mode changes as follows.

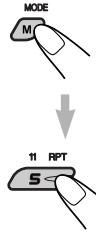

REPEAT indicator RPT indicator
 (See the following table.)
 Ex.: When you select "Repeat 1."

Mode	RPT Indicator	Plays repeatedly
Repeat 1	Highlighted	The current file (or specified file).
Repeat 2	Flashes	All files of the current directory (or specified directory).

When Repeat Play is turned on, the REPEAT indicator lights up or flashes on the display.

To play back only intros (Intro Scan)

You can play back the first 15 seconds of each file sequentially.

- 1 Press MODE (M) to enter the functions mode while playing an MP3 disc.
 "Mode" appears on the display.
- 2 Press INT (intro), while "Mode" is still on the display, so that the INT indicator is highlighted on the display.
 Each time you press INT, the intro scan mode changes as follows:

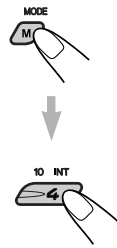

INTRO indicator INT indicator
 (See the following table.)
 Ex.: When you select "Intro 1."

Mode	INT Indicator	Plays the beginnings
Intro 1	Highlighted	Of all files on the disc.
Intro 2	Flashes	Of the first file of all directories.

When Intro Scan is turned on, the INTRO indicator lights up or flashes on the display.

Changing the display pattern

By pressing DISP (D), you can change the information shown on the display.

Each time you press the button, the display patterns change as follows :

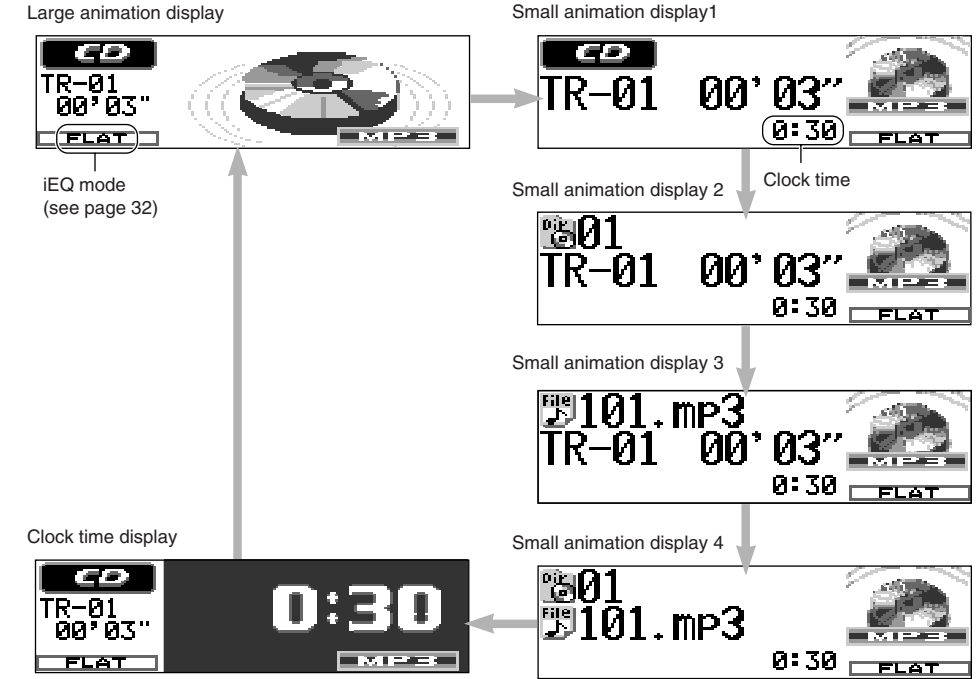

The above diagram shows the examples of the display when "ID3 Tag" is set to "Off."

Notes:

- When the directory name is shown, the "Dir" indicator () lights up. When the file name is shown, the "File" indicator () lights up.
- If the information cannot be shown at a time, it will scroll on the display.
Some characters or symbols cannot be shown (blanked or substituted) on the display.
- If "ID3 Tag" is set to "On" (see page 38) if a disc has an ID3 tag, ID3 tag information will appear on the display. The album name/performer appears on the display instead of the directory name, while track title appears instead of the file name.



Adjusting the sound

You can adjust the sound characteristics to your preference.

1 Select the item you want to adjust.

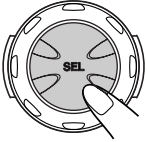

Each time you press the button, the adjustable items change as follows:

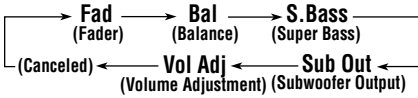

Indication	To do:	Range
Fad*1	Adjust the front and rear speaker balance.	R06 (Rear only) F06 (Front only)
Bal	Adjust the left and right speaker balance.	L06 (Left only) R06 (Right only)
S. Bass*2	Adjust the bass.	00 (min.) 08 (max.)
Sub Out*3	Adjust the subwoofer output level and cutoff frequency level.	00 (min.) 12 (max.) Low/Mid/High
Vol Adj*4	Adjust and store the input level of each source.	-12 (min.) +12(max.)

*1 If you are using a two-speaker system, set the fader level to "00."

*2 The richness and fullness of the bass sound is clearly maintained regardless of how low you set the volume.

*3 This takes effect only when a subwoofer is connected.

*4 By adjusting the input level to match it to the FM sound level, you will not need to adjust the volume level each time you change the source. This adjustment is memorized for each source except FM.

2 Adjust the level.

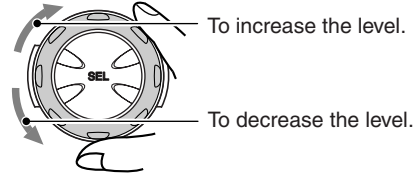

While adjusting fader and balance

—Fad, Bal:

You can make these two adjustments at the same time, by referring to the indication on the display.

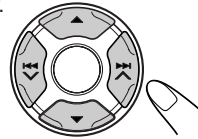

- Press ▲ (up) or ▼ (down) to adjust the fader.
- Press ►► ▲ or ◀◀ ▼ to adjust the balance.

While adjusting subwoofer output

—Sub Out:

You can also set an appropriate cutoff frequency level according to the subwoofer connected:

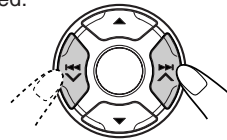

- Press ►► ▲ or ◀◀ ▼ to select "Low," "Mid," or "High."

Low: Frequencies higher than 50 Hz are cut off to the subwoofer.

Mid: Frequencies higher than 80 Hz are cut off to the subwoofer.

High: Frequencies higher than 115 Hz are cut off to the subwoofer.



Selecting preset sound modes (iEQ: i-equalizer)

You can select a preset sound mode suitable to the music genre.

- There is a time limit in doing the following procedure. If the setting is canceled before you finish, start from step 1 again.

1 Press MODE (M).



"Mode" appears on the display.

2 Press EQ (equalizer) while "Mode" is still on the display.

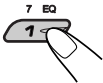

The last selected sound mode is called up.



Ex.: If you have selected "Flat" previously

3 Select the sound mode you want.

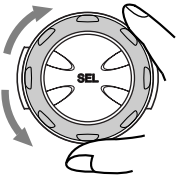

As you turn the control dial, the sound modes change as follows:

- Flat ⇄ Hard Rock ⇄ R&B* ⇄ Pop ⇄
 Jazz ⇄ Dance Music ⇄ Country ⇄
 Reggae ⇄ Classic ⇄ User 1 ⇄ User 2 ⇄
 User 3 ⇄ (back to the beginning)

* *Rhythm and Blues*

To cancel the sound mode, select "Flat" in step 3.

Note:

For details about the preset settings of each sound mode, see page 34.

Storing your own sound adjustments

You can adjust the sound modes to your preference and store your own adjustments in memory (User 1, User 2 and User 3).

- There is a time limit in doing the following procedure. If the setting is canceled before you finish, start from step 1 again.

1 Press MODE (M).



"Mode" appears on the display.

2 Press EQ (equalizer) while "Mode" is still on the display.

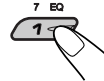

3 Select the sound mode you want to adjust.



Ex.: If you have selected "R & B"

4 Enter the sound adjustment mode.

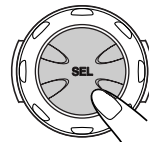

The following sound mode adjustment screen appears on the display.



5 Make adjustments as you like, referring to the table “Sound adjustment items.”

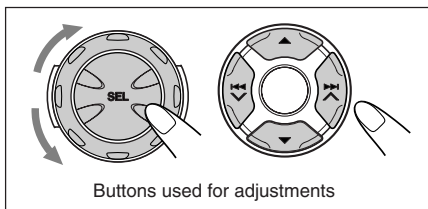

- 1) Press ►►| ▲ or |◄◄ ▼ to select the frequency band—Low, Mid, or High.
- 2) Turn the control dial to select the center frequency for the selected band.
- 3) Press ▲ (up) or ▼ (down) to adjust the level of the selected band.
- 4) Press SEL (select) to enter the Q level (band width) adjustment mode for the selected band.
- 5) Turn the control dial to adjust the Q level for the selected band.
- 6) Repeat steps 1) to 5) to adjust the other frequency bands.

6 Exit from the sound adjustment mode.

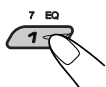

The confirmation message appears—whether you want to store the adjustment.



If you want to cancel the adjustments, press any button other than SEL (select).

7 Select one of the user sound modes (User 1, User 2, User 3).



8 Store the adjustment in the selected user sound mode.



Ex.:When you have selected “User1”

Sound adjustment items

Band	Selectable values		
	Low	Mid	High
Center frequency	50 Hz 80 Hz 120 Hz	700 Hz 1 kHz 2 kHz	8 kHz 12 kHz
Q (band width)	Q1 (min.) Q4 (max.)	Q1 (min.) Q2 (max.)	(Fixed)
Level	-06 (min.) +06 (max.)	-06 (min.) +06 (max.)	-06 (min.) +06 (max.)



Activating the level meter

You can show the level meters on the display while playing any source. This unit is equipped with three level meter patterns.

- There is a time limit in doing the following procedure. If the setting is canceled before you finish, start from step 1 again.

1 Press MODE (M).



“Mode” appears on the display.

2 Press EQ (equalizer) twice while “Mode” is still on the display.

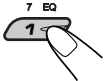

The last selected level meter appears on the display.

3 Select the level meter pattern you want.



As you turn the control dial, the level meters change as follows:

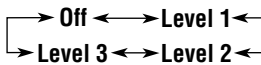

Level Meter 1:

The audio level meter fluctuates vertically.

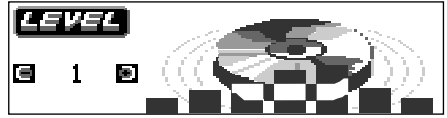

Level Meter 2:

The speaker on the display vibrates as input audio level changes.

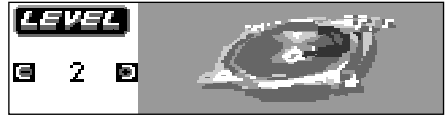

Level Meter 3:

The left and right audio level meters appear.

- If the small animation display is selected, only one audio level meter can be shown.



The list below shows the preset value settings for each sound mode (see also page 32).

Sound modes	Preset values							
	Low			Mid			High	
	C.Freq.	Q (Width)	Level	C.Freq.	Q (Width)	Level	C.Freq.	Level
Flat	50 Hz	Q1	+00	700 Hz	Q1	+00	8 kHz	+00
Hard Rock	80 Hz	Q2	+03	700 Hz	Q1	+00	8 kHz	+02
R & B	80 Hz	Q3	+03	2 kHz	Q2	+01	12 kHz	+03
Pop	120 Hz	Q1	+02	2 kHz	Q2	+01	12 kHz	+02
Jazz	80 Hz	Q1	+03	1 kHz	Q1	+01	8 kHz	+03
Dance Music	50 Hz	Q2	+04	700 Hz	Q1	-02	8 kHz	+01
Country	50 Hz	Q4	+02	700 Hz	Q1	+00	12 kHz	+02
Reggae	80 Hz	Q1	+03	2 kHz	Q2	+02	12 kHz	+02
Classic	120 Hz	Q1	+03	1 kHz	Q1	+00	8 kHz	+02
User 1	50 Hz	Q1	+00	700 Hz	Q1	+00	8 kHz	+00
User 2	50 Hz	Q1	+00	700 Hz	Q1	+00	8 kHz	+00
User 3	50 Hz	Q1	+00	700 Hz	Q1	+00	8 kHz	+00

Changing the general settings (PSM)

You can change the items listed on the next page by using the PSM (Preferred Setting Mode) control.

- The PSM items are grouped into five categories—"Disp (display)," "Clock," "Tuner," "Color," and "Audio."

Basic Procedure

- 1** Press and hold SEL (select) for more than 2 seconds so that one of the PSM items appears on the display. (See pages 36 and 37.)



- 2** Press ▲ (up) or ▼ (down) repeatedly until your desired PSM category appears on the left side of the display.



- 3** Select the PSM item you want to adjust.



- 4** Adjust the PSM item selected.



- 5** Repeat steps 2 to 4 to adjust the other PSM items if necessary.

- 6** Finish the setting.

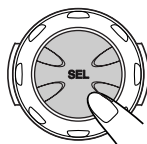

To set clock—Clock Hr, Clock Min, 24H/12H

You can set the clock using the PSM control.

- You can select either 12-hour system or 24-hour system.

- 1** Press and hold SEL (select) for more than 2 seconds so that one of the PSM items appears on the display.
- 2** Press ▲ (up) or ▼ (down) repeatedly until "Clock" is selected as the PSM category (it is shown on the left side of the display).
- 3** Press ►►| ▲ or |◄◄ ▼ to select "Clock Hr (hour)."
- 4** Turn the control dial to adjust the hour.
- 5** Press ►►| ▲ or |◄◄ ▼ to select "Clock Min (minute)."
- 6** Turn the control dial to adjust the minute.
- 7** Press ►►| ▲ or |◄◄ ▼ to select "24H/12H."
- 8** Turn the control dial to select either "24Hours" or "12Hours."
- 9** Press SEL (select) to finish the setting.

Preferred Setting Mode (PSM) items

The PSM items are grouped into five categories—“Disp (display),” “Clock,” “Tuner,” “Color,” and “Audio.” To select a desired item, first select the category where the desired item is listed.

	Indications	Selectable values	Factory-preset settings	See page
Disp (display)	MovieDemo Movie demo	Interval ↔ Off ↕ All Time ↕	Interval	8, 37
	SRC Anime Source animation	On Off	On	37
	Scroll Scroll mode	Once ↔ Auto ↕ Off ↕	Once	37
	Dimmer Dimmer mode	Auto ↔ Off ↕ On ↕	Auto	37
	Contrast Contrast	1 — 10	5	38
	LCD Type Display type	Positive ↔ Negative ↕ Auto ↕	Positive	38
	Font Type Font type	1 2	1	38
	ID3 Tag ID3 Tag display	On Off	On	38
Clock	Clock Hr Hour adjustment	0 — 12 (24)	0 (0:00)	35
	Clock Min Minute adjustment	00 — 59	00 (0:00)	35
	24H/12H 24/12-hour time display	12Hours 24Hours	24Hours	35
	Auto Adj Automatic clock setting	On Off	On	19
Tuner	PTY Stnby PTY standby	Off → 29 programme types (see page 19) ↕	Off	16
	AF-Regn'l Alternate frequency/ Regionalization reception	AF ↔ AF Reg ↕ Off*1 ↕	AF	15
	TA Volume Traffic announcement volume	Volume 0 — Volume 50	Volume 20	18
	P-Search Programme search	On Off	Off	18
	IF Filter Intermediate frequency filter	Auto Wide	Auto	38
	DAB AF*2 Alternative frequency search	On Off	On	52

*1 Displayed only when “DAB AF” is set to “Off.”

*2 Displayed only when the DAB tuner is connected.

Indications		Selectable values		Factory-preset settings	See page	
Color	Mode	Color mode	Source	User	Source	39
	Source ^{*3}	Source color selection	See page 39 for details		AllSource	39
		AllSource ^{*4} (Selected source)	See page 39 for details		Every	39
	User ^{*5}	User color selection	Day	Night	Day	41
		Red ^{*5}	Red	0 — +11	Day:+7 / Night:+5	41
		Green ^{*5}	Green	0 — +11	Day:+7 / Night:+5	41
		Blue ^{*5}	Blue	0 — +11	Day:+7 / Night:+5	41
Audio	Beep	Key-touch tone	On	Off	On	38
	Ext Input ^{*6}	External component	Changer	Line In	Changer	38
	Telephone	Telephone muting	Off	↔ Muting 1 ↕ Muting 2 ↕	Off	38

^{*3} Displayed only when “Mode” is set to “Source.”

^{*4} What appears actually here—source name—varies according to the “Source” setting.

^{*5} Displayed only when “Mode” is set to “User.”

^{*6} Displayed only when one of the following sources is selected – FM, AM and CD.

To set the movie demo—MovieDemo

When shipped from the factory, the movie demo has been activated (“Interval” is selected).

- Interval: If no operation is done for about 20 seconds, the movie demo and playback source indication alternately appears on the display.
- All Time: If no operation is done for about 20 seconds, the movie demo automatically starts.
- Off: Cancels the movie demo.

To set the source animation on the display—SRC Anime

When changing the source, the display shows the source animation. If you do not want this animation, you can turn it off.

- On: The source animation appears just after you change the source.
- Off: Cancels the source animation.

To select the scroll mode for disc information and the DAB text—Scroll

You can select the scroll mode for disc information and for the DAB radio text (DLS: Dynamic Label Segment).

- Once: While showing the disc information: scrolls the disc information only once. While showing the DAB text: scrolls the detailed DAB text only once.
- Auto: While showing the disc information: repeats the scroll (in 5-second intervals). While showing the DAB text: scrolls the detailed DAB text.
- Off: While showing the disc information: cancels scroll mode. While showing the DAB text: shows only headline if any.

To select the dimmer mode—Dimmer

When you turn on the car headlights, the display automatically dims (Auto Dimmer). When shipped from the factory, Auto Dimmer mode is activated.

- Auto: Activates Auto Dimmer.
- Off: Cancels Auto Dimmer.
- On: Always dims the display.

Note:

Auto Dimmer equipped for this unit may not work correctly on some vehicles, particularly on those having a control dial for dimming. In this case, set the dimmer mode to “On” or “Off.”

To adjust the display contrast level— Contrast

You can adjust the display contrast level among 1 (dark) to 10 (bright).

To select the display illumination pattern—LCD Type

You can select the display illumination patterns according to your preference.

- Auto: Positive pattern will be selected during the day time (while the headlights are turned off); on the other hand, negative pattern will be used during the night time (while the headlights are turned on.)
- Positive: Positive (normal) pattern of the display.
- Negative: Negative pattern of the display.

To select the font on the display—Font Type

You can change the font types used on the display. Select either “1” or “2” according to your preference.

To turn the tag display on or off—ID3 Tag

An MP3 file can contain file information called “ID3 Tag” where its album name, performer, track title, etc. are recorded.

There are two versions—ID3v1 (ID3 Tag version 1) and ID3v2 (ID3 Tag version 2). This unit is compatible only with ID3v1.

- On: Turns on the ID3 tag display while playing MP3 files.
* If an MP3 file does not have ID3 tags, directory name and file name appear.

Note:

If you change the setting from “Off” to “On” while playing an MP3 file, the tag display will be activated when the next file starts playing.

- Off: Turns off the ID3 tag display while playing MP3 files. (Only the directory name and file name can be shown.)

To change the FM tuner selectivity— IF Filter

In some areas, adjacent stations may interfere with each other. If this interference occurs, noise may be heard.

- Auto: When this type of interference occurs, this unit automatically increases the tuner selectivity so that interference noise will be reduced. (But the stereo effect will also be lost.)
- Wide: Subject to the interference from adjacent stations, but sound quality will not be degraded and the stereo effect will not be lost.

To turn on/off the key-touch tone—Beep

You can deactivate the key-touch tone if you do not want it to beep each time you press a button.

- On: Activates the key-touch tone.
- Off: Deactivates the key-touch tone.

To select the external component to use— Ext Input

You can connect the external component to the CD changer jack on the rear using the Line Input Adaptor KS-U57 (not supplied).

To use the external component as the playback source through this unit, you need to select which component—CD changer or external component—to use.

- Changer: To use the CD changer.
- Line In: To use the external component other than CD changer.

Note:

For connecting the Line Input Adaptor KS-U57 and the external component, refer to the Installation/Connection Manual (separate volume).

To select the telephone muting—Telephone

This mode is used when a cellular phone system is connected. Depending on the phone system used, select either “Muting 1” or “Muting 2,” whichever mutes the sounds from this unit.

When shipped from the factory, this mode is deactivated.

- Muting 1: Selects this if this setting can mute the sounds.
- Muting 2: Selects this if this setting can mute the sounds.
- Off: Cancels the telephone muting.

Changing the display color

You can set the display color using the PSM control. By selecting “Source” as the “Mode” (color mode) setting, you can select your favorite color for each source (or for all sources).

Note:

When selecting “User” as the “Mode” setting, you can adjust and store your own colors as you like. See page 40.

Setting the desired color for each source—Source

Once you have set the color for each source (or for all sources), the display illuminates in the selected color when the source is selected.

- 1 Press and hold SEL (select) for more than 2 seconds so that one of the PSM items appears on the display. (See pages 36 and 37.)



- 2 Press ▲ (up) or ▼ (down) repeatedly until “Color” appears as the PSM category on the left side of the display.



- 3 Select “Mode.”

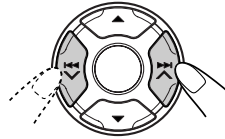

Currently selected setting for “Mode”

- 4 Select “Source” as the “Mode” (color mode) setting.

As you turn the control dial, the “Mode” settings alternate between “Source” and “User.”



Source ↔ User

- 5 Enter the source selecting mode.

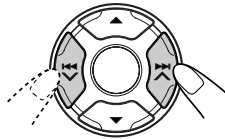

Currently selected setting for “Source”

CONTINUED ON THE NEXT PAGE

6 Select the source that you want to set the display color for.

As you turn the control dial, the source names change as follows:

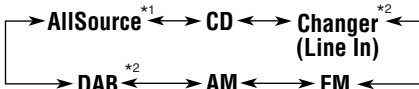
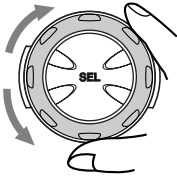

*1 When you select "AllSource," you can use the same color for all sources.

*2 Selected only when these components are connected.

7 Enter the color selecting mode.



8 Select the display color.

As you turn the control dial, the colors change as follows:



- Every*1 ⇄ Aqua ⇄ Sky ⇄ Sea ⇄
 Leaves ⇄ Grass ⇄ Rose ⇄ Cherry ⇄
 Orange ⇄ Honey ⇄ Violet ⇄ Grape ⇄
 Snow ⇄ User*2 ⇄ (back to the beginning)

*1 When you select "Every," the color changes every two seconds (changing to every color listed above except "User.")

*2 When you select "User," one of the original colors—"Day" or "Night" can be selected depending on the "User" setting.

9 Repeat steps 5 to 8 to select the color for each source (except when selecting "AllSource" in step 6).

10 Finish the setting.

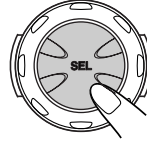

Selecting or adjusting your own color—User

You can adjust and store your own colors—"Day" and "Night," and select one of them as the display color for any desired source.

- Day: Can be used as your user color during the day time (while the headlights are turned off).
- Night: Can be used as your user color during the night time (while the headlights are turned on.)

1 Press and hold SEL (select) for more than 2 seconds so that one of the PSM items appears on the display. (See pages 36 and 37.)



2 Press ▲ (up) or ▼ (down) repeatedly until "Color" appears as the PSM category on the left side of the display.

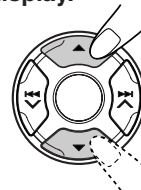

3 Select “Mode.”



4 Select “User” as the “Mode” (color mode) setting.

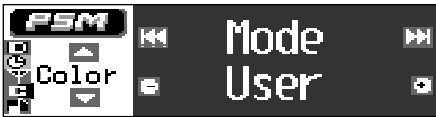
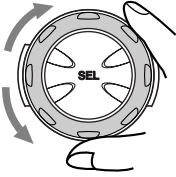

5 Select “User.”



6 Select either “Day” or “Night” as your user color.



As you turn the control dial, the user color alternates between “Day” and “Night.”

- If you want to select the user color, but do not need to adjust the color, go to step 9 to finish the setting.
- If you want to adjust the user color, go to the next step.

7 Adjust the user color.

- 1) Press **▶▶|▲** or **◀◀▼** to select one of three primary colors—“Red” “Green,” and “Blue.”

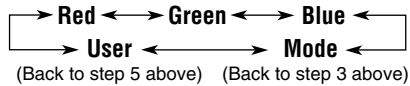
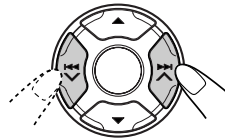

- 2) Turn the control dial to adjust the selected primary color.
You can adjust within the range of 0 to +11.

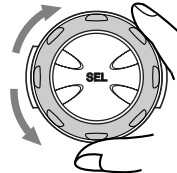

- 3) Repeat steps 1) and 2) to adjust the other primary colors.

8 Repeat steps 6 and 7 to adjust the other user color—“Day” or “Night.”

9 Finish the setting.

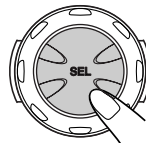

Note:

To use the color adjusted in this procedure, select “User” in the step 8 (“Select the display color”) of “Setting the desired color for each source —Source.” (See page 40.)

Assigning names to the sources

You can assign names to discs (both in this unit and in the CD changer) and the external component.

After assigning a name, it will appear on the display when you select the source.

Sources	Maximum number of characters
CDs*	up to 32 characters (up to 40 discs)
External component	up to 8 characters

* You cannot assign a name to a CD Text or an MP3 disc.

1 Select a source you want to assign a name to.



When you select a source, the power automatically comes on.

2 Press and hold SEL (select) for more than 2 seconds while pressing DISP (D).



Ex.: When you select CD as the source

3 Select the character set you want while the first character position is flashing.



Each time you press the button, the character set changes as follows:

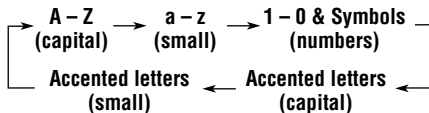

4 Select a character.

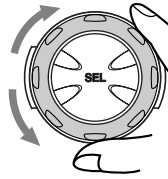

- About the available characters, see page 57.

5 Move the cursor to the next (or previous) character position.



6 Repeat steps 3 to 5 until you finish entering the name.

7 Finish the procedure while the last selected character is flashing.



To erase the entered characters

Insert spaces using the same procedure described above. (About the available characters, see page 57.)

Notes:

- When you try to assign a name to the 41st disc, you cannot enter the text entry mode (and will hear a beep sound if "Beep" has been set to "On": see page 38). (In this case, delete unwanted names before assignment.)
- When the CD changer is connected, you can assign names to discs in the CD changer. These names can also be shown on the display if you insert the discs in this unit.

Detaching the control panel

You can detach the control panel when leaving the car.

When detaching or attaching the control panel, be careful not to damage the connectors on the back of the control panel and on the panel holder.

Detaching the control panel

Before detaching the control panel, be sure to turn off the power.

- 1 **Unlock the control panel.**

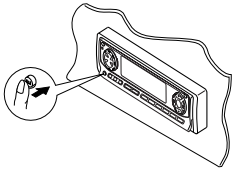

- 2 **Pull the control panel out of the unit.**

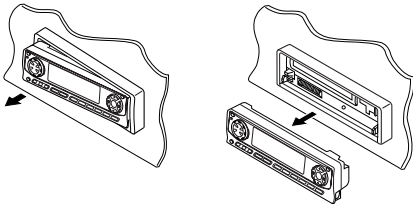

- 3 **Put the detached control panel into the provided case.**

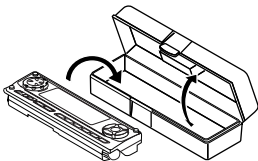

Attaching the control panel

- 1 **Insert the right side of the control panel into the groove on the panel holder.**

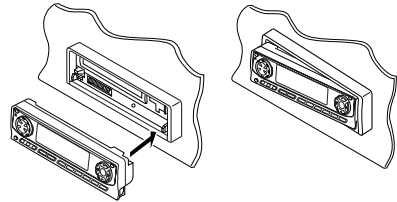

- 2 **Press the left side of the control panel to fix it to the panel holder.**

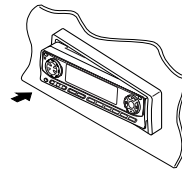

Note on cleaning the connectors:

If you frequently detach the control panel, the connectors will deteriorate.

To minimize this possibility, periodically wipe the connectors with a cotton swab or cloth moistened with alcohol, being careful not to damage the connectors.

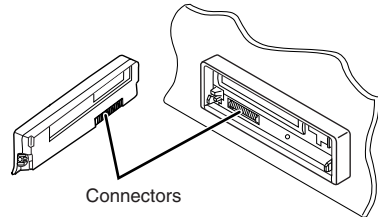



CD CHANGER OPERATIONS

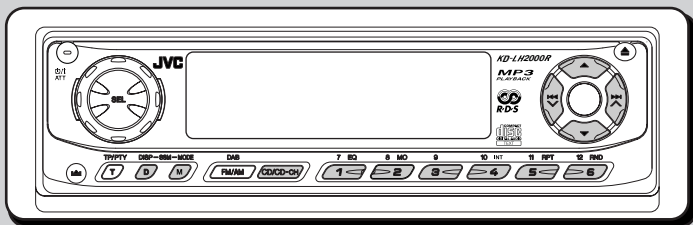

We recommend that you use one of the CH-X series with your unit.

If you have another JVC CD automatic changer, consult your JVC IN-CAR ENTERTAINMENT dealer for connections.

- For example, if your CD automatic changer is one of the KD-MK series, you need a cord (KS-U15K) for connecting it to this unit.

Before operating your CD automatic changer:

- Refer also to the Instructions supplied with your CD changer.
- If no discs are in the magazine of the CD changer or the discs are inserted upside down, "No Disc" will flash on the display. If this happens, remove the magazine and set the discs correctly.
- If "Reset 1" – "Reset 8" flashes on the display, something is wrong with the connection between this unit and the CD changer. If this happens, check the connection and make sure the cords are connected firmly. Then, press the reset button of the CD changer.

Playing CDs

Select the CD automatic changer (CD-CH).

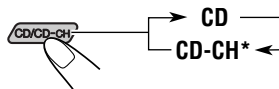

- * If you have changed the "Ext Input" setting to "Line In" (see page 38), you cannot select the CD changer.

Playback starts from the first track of the first disc. All tracks of all discs are played back.



Note on One-Touch Operation:

When you press CD/CD-CH, the power automatically turns on. You do not have to press ATT to turn on the power.

To change the information shown on the display

Press DISP (D) repeatedly.

For details, see "Changing the display patten" on page 23.

Note:

If you change the source or turn off the unit, CD play also stops.

Next time you select "CD-CH" as the source, CD play starts from where playback has been stopped previously.



Locating a track or a particular portion on a CD

To fast-forward or reverse the track

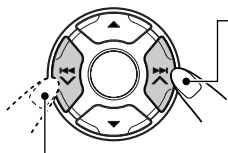

Press and hold **▶▶|▲**, while playing a disc, to fast-forward the track.

Press and hold **◀◀|▼**, while playing a disc, to reverse the track.

To go to the next track or the previous tracks

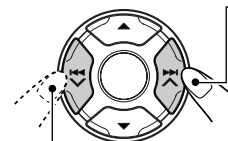

Press **▶▶|▲** briefly, while playing a disc, to go ahead to the beginning of the next track. Each time you press the button consecutively, the beginning of the next tracks is located and played back.

Press **◀◀|▼** briefly, while playing a disc, to go back to the beginning of the current track. Each time you press the button consecutively, the beginning of the previous tracks is located and played back.

Selecting a disc

To go to a particular disc directly

Press the number button corresponding to the disc number to start its playback (while the CD changer is playing).

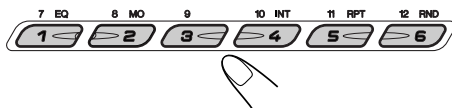

- To select a disc number from 1 – 6:
Press 1 (7) – 6 (12) briefly.
- To select a disc number from 7 – 12:
Press and hold 1 (7) – 6 (12) for more than 1 second.

To go to the next discs or the previous discs

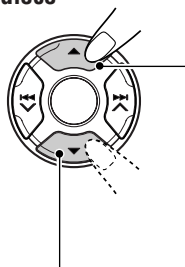

Press **▲** (up), while playing a disc, to go to the next disc. Each time you press the button consecutively, the first track of the next disc is located and played back.

Press **▼** (down) while playing a disc, to go back to the previous disc. Each time you press the button consecutively, the first track of the previous disc is located and played back.



To select a disc using the disc lists

If you forget what discs are loaded in the CD changer, you can show the disc title list and select a disc on the list shown on the display.

- The display can show only six disc names at a time.

1 While playing a CD, press and hold **▲ (up)** or **▼ (down)** until a disc name list appears on the display.



Note:

If a disc has an assigned disc name, it will be shown on the display. However, if the disc has not been played before, its disc number will appear.

2 Press **▲** or **▼** to show the other disc name list, if necessary.



3 Select the number (1 – 6) for the disc you want to play.

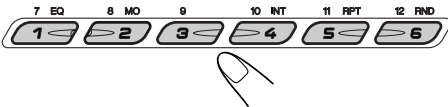

Selecting CD playback modes

To play back tracks at random (Random Play)

You can play back the tracks at random.



1 Press MODE (M) to enter the functions mode while playing a disc.
“Mode” appears on the display.

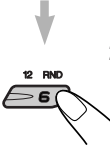

2 Press RND (random), while “Mode” is still on the display, so that the RND indicator is highlighted on the display. Each time you press RND, the random play mode changes as follows:



RANDOM indicator

RND indicator
(See the following table.)

Ex.: When you select “Random 1.”

Mode	RND Indicator	Plays at random
Random 1	Highlighted	All tracks of the current disc, then the tracks of the next disc and so on.
Random 2	Flashes	All tracks of all discs inserted in the magazine.

When Random Play is turned on, the RANDOM indicator lights up or flashes on the display.

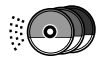

To play back tracks repeatedly (Repeat Play)

You can play back the current track or the tracks on the current disc repeatedly.



1 Press MODE (M) to enter the functions mode while playing a disc. "Mode" appears on the display.

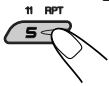

2 Press RPT (repeat), while "Mode" is still on the display, so that the RPT indicator is highlighted on the display. Each time you press RPT, the repeat play mode changes as follows:



REPEAT indicator

RPT indicator
(See the following table.)

Ex.: When you select "Repeat 1."

Mode	RPT Indicator	Plays repeatedly
Repeat 1	Highlighted	The current track (or specified track).
Repeat 2	Flashes	All tracks of the current disc (or specified disc).

When Repeat Play is turned on, the REPEAT indicator lights up or flashes on the display.

To play back only intros (Intro Scan)

You can play back the first 15 seconds of each track sequentially.



1 Press MODE (M) to enter the functions mode while playing a disc. "Mode" appears on the display.

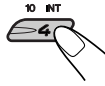

2 Press INT (intro), while "Mode" is still on the display, so that the INT indicator is highlighted on the display. Each time you press INT, the intro scan mode changes as follows:

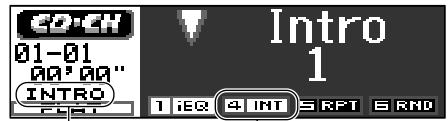

INTRO indicator

INT indicator
(See the following table.)

Ex.: When you select "Intro 1."

Mode	INT Indicator	Plays the beginnings
Intro 1	Highlighted	Of all tracks on all inserted discs.
Intro 2	Flashes	Of the first track on each inserted disc.

When Intro Scan is turned on, the INTRO indicator lights up or flashes on the display.



EXTERNAL COMPONENT OPERATIONS

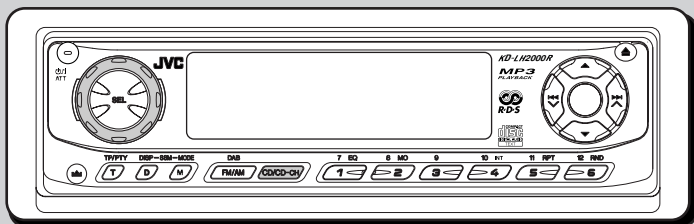

Playing an external component

You can connect the external component to the CD changer jack on the rear using the Line Input Adaptor KS-U57 (not supplied).

Preparations:

- For connecting the Line Input Adaptor KS-U57 and the external component, refer to the Installation/Connection Manual (separate volume).
- Before operating the external component using the following procedure, select the external input correctly. (See “To select the external component to use—Ext Input” on page 38.)

- 1** Select the external component (Line In).

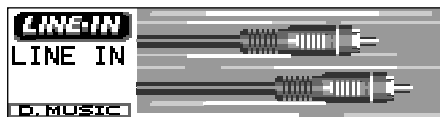
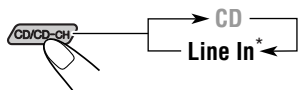

- 2** Turn on the connected component and start playing the source.

- 3** Adjust the volume.



- 4** Adjust the sound as you want. (See pages 31 – 34.)

* If “Line In” does not appear on the display, see page 38 and select the external input (“Line In”).

* Displayed only when one of the following sources is selected—FM, AM and CD.

Note on One-Touch Operation:

When you press CD/CD-CH, the power automatically comes on. You do not have to press  / I ATT to turn on the power.

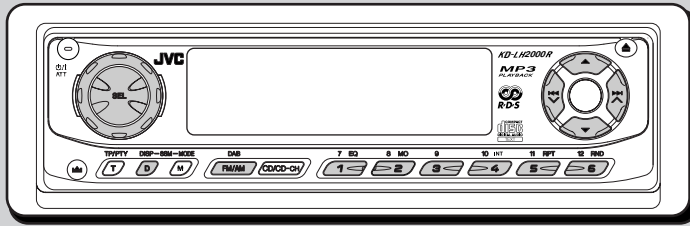

We recommend that you use DAB (Digital Audio Broadcasting) tuner KT-DB1500 with your unit. If you have another DAB tuner, consult your JVC IN-CAR ENTERTAINMENT dealer.

- Refer also to the Instructions supplied with your DAB tuner.

What is DAB system?

DAB is one of the digital radio broadcasting systems available today. It can deliver CD quality sound without any annoying interference and signal distortion.

Furthermore, it can carry text, pictures and data.

In contrast to FM broadcast, where each programme is transmitted on its own frequency, DAB combines several programmes (called “services”) to form one “ensemble.”

In addition, each “service”—called “primary service”—can also be divided into its components (called “secondary service”).

With the DAB tuner connected with this unit, you can enjoy these DAB services.

Note:

When reception switches between DAB and FM, the listening volume level may increase or decrease inconveniently. This change in the volume level results from unequal audio injection levels at broadcaster site, but not from the malfunction of this unit.

To prevent this inconvenience, you can adjust the DAB input level (see page 31).

Tuning in to an ensemble and one of the services

A typical ensemble has 6 or more programmes (services) broadcast at the same time. After tuning in to an ensemble, you can select a service you want to listen to.

Before you start...

Press FM/AM DAB briefly if CD, CD changer or external component is the current source.

1 Select the DAB tuner.



Each time you press and hold the button, the DAB tuner and the FM/AM tuner are alternately selected.

DAB ↔ FM/AM



Last received service of the selected band is tuned in.

2 Select the DAB band (DAB1, DAB2 or DAB3).

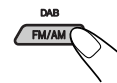

Each time you press the button, the DAB band changes as follows:



Note:

This receiver has three DAB bands (DAB1, DAB2, DAB3). You can use any one of them to tune in to an ensemble.

3 Start searching for an ensemble.

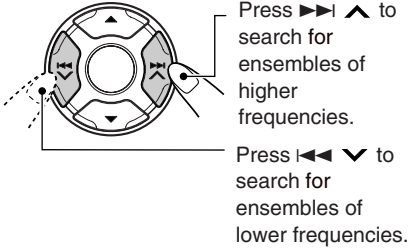

When an ensemble is received, searching stops.

To stop searching before an ensemble is received, press the same button you have pressed for searching.

4 Select a service (either primary or secondary) you want to listen to.

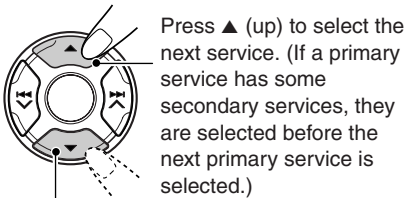

Press ▼ (down) to select the previous service (either primary or secondary).

To tune in to a particular ensemble without searching:

- 1 Press and hold FM/AM DAB to select DAB tuner as the source.
- 2 Press FM/AM DAB repeatedly to select the DAB band (DAB1, DAB2 or DAB3).
- 3 Press and hold ►► ▲ or ◀◀ ▼ for more than 1 second.
- 4 Press ►► ▲ or ◀◀ ▼ repeatedly until the ensemble you want is reached.
 - If you hold down the button, the frequency keeps changing until you release the button.
- 5 Press ▲ (up) or ▼ (down) to select a service (either primary or secondary) you want to listen to.

To restore the FM/AM tuner

Press and hold FM/AM DAB again.

Storing DAB services in memory

You can preset up to 6 DAB services in each DAB band (DAB1, DAB2 and DAB3) manually.

1 Select the DAB tuner.

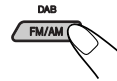

Each time you press and hold the button, the DAB tuner and the FM/AM tuner are alternately selected.

DAB ↔ FM/AM

2 Select the DAB band (DAB1, DAB2 or DAB3) you want.

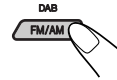

Each time you press the button, the DAB band changes as follows:



3 Tune in to an ensemble you want.

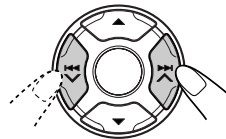

4 Select a service of the ensemble you want.

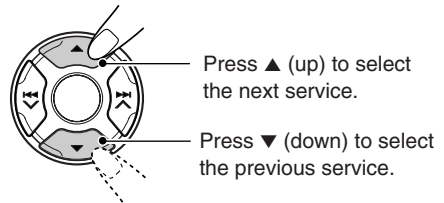

- 5** Press and hold the number button (in this example, 1) you want to store the selected service into for more than 2 seconds.

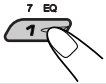

The display pattern automatically changes to the non-animation display and the preset number flashes (then the previous display pattern resumes).

- 6** Repeat the above procedure to store other DAB services into other preset numbers.

Notes:

- You can only preset primary DAB services. If you store a secondary service, its primary service will be stored instead.
- A previously preset DAB service is erased when a new DAB service is stored in the same preset number.

Tuning in to a preset DAB service

You can easily tune in to a preset DAB service. Remember that you must store services first. If you have not stored them yet, see page 50.

Selecting a preset service directly

- 1** Select the DAB tuner.

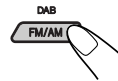

Each time you press and hold the button, the DAB tuner and the FM/AM tuner are alternately selected.

DAB ↔ **FM/AM**

- 2** Select the DAB band (DAB1, DAB2 or DAB3) you want.

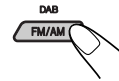

Each time you press the button, the DAB band changes as follows:



- 3** Select the number (1 – 6) for the preset DAB service (primary) you want.

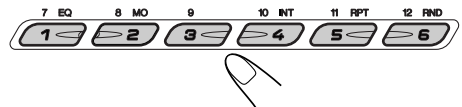

Note:

If the selected primary service has some secondary services, pressing the same number button repeatedly will tune in to the secondary services.

Selecting a preset service using the preset service list

If you forget what services are stored in what preset number, you can check the preset service list, then select your desired service on the list.

1 Select the DAB tuner.

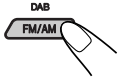

Each time you press and hold the button, the DAB tuner and the FM/AM tuner are alternately selected.

DAB ←→ FM/AM

2 Select the DAB band (DAB1, DAB2 or DAB3) you want.

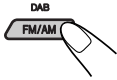

Each time you press the button, the DAB band changes as follows:



3 Press and hold ▲ (up) or ▼ (down) until the preset service list for the current band (DAB1, DAB2, or DAB3) appears on the display.



DAB	1 HR1	4 HR3
DAB1	2 No Serv.	5 HR4
Preset	3 FFH	6 No Serv.
FLAT		

4 If necessary, press ▲ (up) or ▼ (down) until the preset service list you want (DAB1, DAB2, or DAB3) appears on the display.

5 Select the number (1 – 6) for the preset service you want.

What you can do more with DAB

Tracing the same program automatically (Alternative Reception)

You can keep listening to the same program.

• While receiving a DAB service:

When driving in an area where a service cannot be received, this unit automatically tunes in to another ensemble or FM RDS station, broadcasting the same program.

• While receiving an FM RDS station:

When driving in an area where a DAB service is broadcasting the same program as the FM RDS station is broadcasting, this unit automatically tunes in to the DAB service.

To use Alternative Reception

When shipped from the factory, Alternative Reception is activated.

- See also “Changing the general settings (PSM)” on page 35.

- 1 Press and hold SEL (select) for more than 2 seconds so that one of the PSM items appears on the display.
- 2 Press ▲ (up) or ▼ (down) repeatedly until “Tuner” is selected as the PSM category (it is shown on the left side of the display).
- 3 Press ►► ▲ or ◀◀ ▼ to select “DAB AF” (alternative frequency).
- 4 Turn the control dial to select the desired mode.
 - On: Traces the program among DAB services and FM RDS stations — Alternative Reception. The AF indicator lights up on the display (see page 14).
 - Off: Deactivates Alternative Reception.

Note:

When Alternative Reception (for DAB services) is activated, Network-Tracking Reception (for RDS stations: see page 14) is also activated automatically. On the other hand, Network-Tracking Reception cannot be deactivated without deactivating Alternative Reception.

- 5 Press SEL (select) to finish the setting.

Changing the display pattern

By pressing DISP (D), you can change the information shown on the display.



Each time you press the button, the display patterns change as follows:

Display pattern 1
(Large animation display)



Text indicator*¹

Display pattern 2



Ensemble name

Frequency

Channel no.

Clock time

Display pattern 3



PTY code*³

Service name

Primary/Secondary indicators*²

Display pattern 4*⁴



Display pattern 5
(Clock time display)



*¹ TEXT indicator: implies the current service received is providing DLS (Dynamic Label Segment—DAB radio text information).

*² Primary/Secondary indicators: implies the current service received is either primary or secondary service.

*³ Each service can have several PTY codes. If a service have several PTY codes, they will be shown in turn.

*⁴ Dynamic Label Segment (DLS) will be displayed. See “To select the display mode for disc information and the DAB text—Scroll” on page 37.



TROUBLESHOOTING

ENGLISH

What appears to be trouble is not always serious. Check the following points before calling a service center.

	Symptoms	Causes	Remedies
General Playback	<ul style="list-style-type: none"> • Sound is sometimes interrupted. 	You are driving on rough roads.	Stop playback while driving on rough roads.
		Disc is scratched.	Change the disc.
		Connections are incorrect.	Check the cords and connections.
	<ul style="list-style-type: none"> • Sound cannot be heard from the speakers. 	The volume level is set to the minimum level.	Adjust it to the optimum level.
		Connections are incorrect.	Check the cords and connections.
	<ul style="list-style-type: none"> • CD cannot be played back. 	Disc is inserted upside down.	Insert the disc correctly.
	<ul style="list-style-type: none"> • CD-R/CD-RW cannot be played back. • Tracks on the CD-R/CD-RW cannot be skipped. 	CD-R/CD-RW is not finalized.	<ul style="list-style-type: none"> • Insert a finalized CD-R/CD-RW. • Finalize the CD-R/CD-RW with the component which you used for recording. (See page 56.)
		<ul style="list-style-type: none"> • “No Disc” flashes on the display . 	No disc in the loading slot.
	Disc is inserted incorrectly.		Insert the disc correctly.
	<ul style="list-style-type: none"> • Disc cannot be ejected. 	Disc is locked.	Unlock the disc (See page 22.)
<ul style="list-style-type: none"> • This unit does not work at all. 	The built-in microcomputer may have functioned incorrectly due to noise, etc.	Press the reset button on the panel holder using a ball-point pen after detaching the control panel. (The clock setting and preset stations stored in memory are erased.) (See page 2.)	
<ul style="list-style-type: none"> • “Panel Connect Error” appears on the display. 	The control panel is not attached correctly and firmly.	Remove the control panel, wipe the connectors, then attach it again. (See page 43.)	
FM/AM	<ul style="list-style-type: none"> • SSM (Strong-station Sequential Memory) automatic preset does not work. 	Signals are too weak.	Store stations manually.
	<ul style="list-style-type: none"> • Static noise while listening to the radio. 	The antenna is not connected firmly.	Connect the antenna firmly.



Symptoms	Causes	Remedies	
<ul style="list-style-type: none"> • “No Disc” flashes on the display . 	No disc in the magazine.	Insert a disc.	CD Changer
<ul style="list-style-type: none"> • “Reset 8” flashes on the display . 	This unit is not connected to a CD changer correctly.	Connect this unit and the CD changer correctly and press the reset button of the CD changer.	
<ul style="list-style-type: none"> • “Reset 1” – “Reset 7” flashes on the display. 	_____	Press the reset button of the CD changer.	
<ul style="list-style-type: none"> • Disc cannot be played back. 	MP3 files do not have the extension code—mp3 in their file names.	Add the extension code—mp3 to their file names.	MP3 Playback
	MP3 files are not recorded in the format compliant with ISO 9660 Level 1, ISO 9660 Level 2, or Joliet.	Change the disc. (Record MP3 files using a compliant application.)	
<ul style="list-style-type: none"> • Files skip, or 00’00” appears and playback stops. 	Files are encoded in Layer 1 or Layer 2 format.	Insert a disc that contains files encoded in Layer 3 format.	
<ul style="list-style-type: none"> • Noise is generated. 	The file played back is not an MP3 file (although it has the extension code—mp3).	Skip to another file or change the disc. (Do not add the extension code—mp3 to non-MP3 files.)	
<ul style="list-style-type: none"> • A longer readout time is required (“File Check” keeps flashing on the display). 	Readout time varies due to the complexity of the directory/file configuration.	Do not use too many hierarchies and directories. Also, do not record any other types of audio tracks together with MP3 files.	
<ul style="list-style-type: none"> • Files cannot be played back as you have intended them to play. 	Playback order is determined when the files are recorded.	_____	
<ul style="list-style-type: none"> • Elapsed playing time is not correct. 	This sometimes occurs during play. This is caused by how the files are recorded on the disc.	_____	
<ul style="list-style-type: none"> • “MP3” flashes on the display. 	There are no MP3 files in the current directory.	Select another directory.	
<ul style="list-style-type: none"> • “No Files” appears on the display for a while, then “Please Eject” appears. 	There are no MP3 files in this disc.	Insert a disc that contains MP3 files.	
<ul style="list-style-type: none"> • Correct characters are not displayed. (e.g. album name) 	This unit can only display alphabets (capital: A–Z, small: a–z), numbers, and a limited number of symbols.	_____	



Handling discs

This unit has been designed to play back CDs, CD-Rs, CD-RWs, CD Texts, and MP3 discs.

How to handle discs

When removing a disc from its case, press down the center holder of the case and lift the disc out, holding it by the edges.

- Always hold the disc by the edges. Do not touch its recording surface.

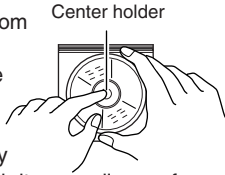

When storing a disc into its case, gently insert the disc around the center holder (with the printed surface facing up).

- Make sure to store discs into the cases after use.

To keep discs clean

A dirty disc may not play correctly. If a disc does become dirty, wipe it with a soft cloth in a straight line from center to edge.



To play new discs

New discs may have some rough spots around the inner and outer edges. If such a disc is used, this unit may reject the disc. To remove these rough spots, rub the edges with a pencil or ball-point pen, etc.

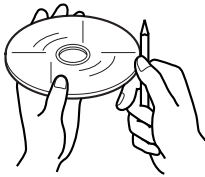

About mistracking:

Mistracking may result from driving on extremely rough roads. This does not damage the unit and the disc, but will be annoying.

We recommend that you stop disc playback while driving on such rough roads.

Moisture condensation

Moisture may condense on the lens inside the unit in the following cases:

- After starting the heater in the car.
- If it becomes very humid inside the car.

Should this occur, the unit may malfunction. In this case, eject the disc and leave the unit turned on for a few hours until the moisture evaporates.

When playing a CD-R or CD-RW

You can play back your original CD-Rs or CD-RWs recorded in audio CD format or in MP3 format. However, they may not be played back depending on their characteristics or recording conditions.

- User-edited CD-Rs (Recordable) and CD-RWs (Rewritable) can be played back only if they are already "finalized."
- Before playing back CD-Rs or CD-RWs, read their instructions or cautions carefully.
- Some CD-Rs or CD-RWs may not be played back on this unit because of their disc characteristics, damage or stain on them, or if the player's lens is dirty.
- CD-Rs or CD-RWs are susceptible to high temperatures or high humidity; so do not leave them inside your car.
- CD-RWs may require a longer readout time. (This is caused by the fact that the reflectance of CD-RWs is lower than for regular CDs.)

CAUTIONS:

- Do not insert 8 cm discs (single CDs) into the loading slot. (Such discs cannot be ejected.)
- Do not insert any disc of unusual shape—like a heart or flower; otherwise, it will cause a malfunction.
- Do not expose discs to direct sunlight or any heat source or place them in a place subject to high temperature and humidity. Do not leave them in a car.
- Do not use any solvent (for example, conventional record cleaner, spray, thinner, benzene, etc.) to clean discs.

AUDIO AMPLIFIER SECTION

Maximum Power Output:

Front: 50 W per channel

Rear: 50 W per channel

Continuous Power Output (RMS):

Front: 19 W per channel into 4 Ω , 40 Hz to 20 000 Hz at no more than 0.8% total harmonic distortion.

Rear: 19 W per channel into 4 Ω , 40 Hz to 20 000 Hz at no more than 0.8% total harmonic distortion.

Load Impedance: 4 Ω (4 Ω to 8 Ω allowance)

Equalizer Control Range:

Low: ± 06 (50 Hz, 80 Hz, 120 Hz)

Mid: ± 06 (700 Hz, 1 kHz, 2 kHz)

High: ± 06 (8 kHz, 12 kHz)

Frequency Response: 40 Hz to 20 000 Hz

Signal-to-Noise Ratio: 70 dB

Line-Out Level/Impedance: 2.0 V/20 k Ω load

Output Impedance: 1 k Ω

TUNER SECTION

Frequency Range:

FM: 87.5 MHz to 108.0 MHz

AM: (MW) 522 kHz to 1 620 kHz
(LW) 144 kHz to 279 kHz

[FM Tuner]

Usable Sensitivity: 11.3 dBf (1.0 μ V/75 Ω)

50 dB Quieting Sensitivity: 16.3 dBf (1.8 μ V/75 Ω)

Alternate Channel Selectivity (400 kHz): 65 dB

Frequency Response: 40 Hz to 15 000 Hz

Stereo Separation: 30 dB

Capture Ratio: 1.5 dB

[MW Tuner]

Sensitivity: 20 μ V

Selectivity: 35 dB

[LW Tuner]

Sensitivity: 50 μ V

CD PLAYER SECTION

Type: Compact disc player

Signal Detection System: Non-contact optical pickup (semiconductor laser)

Number of channels: 2 channels (stereo)

Frequency Response: 5 Hz to 20 000 Hz

Dynamic Range: 96 dB

Signal-to-Noise Ratio: 98 dB

Wow and Flutter: Less than measurable limit

MP3 recording format: MPEG 1/2 Audio Layer 3

Max. Bit Rate: 320 Kbps

GENERAL

Power Requirement:

Operating Voltage: DC 14.4 V
(11 V to 16 V allowance)

Grounding System: Negative ground

Allowable Operating Temperature: 0°C to +40°C

Dimensions (W \times H \times D):

Installation Size: 182 mm \times 52 mm \times 150 mm

Panel Size: 188 mm \times 58 mm \times 14 mm

Mass: 1.4 kg (excluding accessories)

Design and specifications are subject to change without notice.

Available characters

You can use the following characters to assign names to CDs, and external components (see page 42). In addition, these characters are used to display the information such as RDS, ID3v1 tags, DAB, and so on.

Numbers and symbols

0	1	2	3	4
5	6	7	8	9
!	"	#	\$	%
&	'	()	*
+	,	-	.	/
:	;	<	=	>
?	@	_	`	i
¿	£	€	α	space

Accented letters

Capital

Á	À	Â	Ä	Ã
Å	Æ	Ç	Ć	Č
Ç	É	È	Ê	Ë
Ğ	Í	Ì	Î	Ï
Ñ	Ó	Ò	Ô	Õ
Ö	Ø	Ř	Ŕ	Š
Ś	Ş	Ú	Û	Ů
Ü	Ý	Ž	Ż	ß
Ɔ	Ɔ	Ɔ	Ɔ	Ɔ
ı	ı	đ	space	

Small

á	à	â	ä	ã
å	æ	ç	ć	č
ç	é	è	ê	ë
ğ	í	ì	î	ï
ñ	ó	ò	ô	õ
ö	ø	ř	ŕ	š
ś	ş	ú	û	ů
ü	ý	ž	ż	
ı	ı	đ	space	

Having TROUBLE with operation?

Please reset your unit

Refer to page of How to reset your unit

Haben Sie PROBLEME mit dem Betrieb?

Bitte setzen Sie Ihr Gerät zurück

Siehe Seite Zurücksetzen des Geräts

Vous avez des PROBLÈMES de fonctionnement?

Réinitialisez votre appareil

Référez-vous à la page intitulée Comment réinitialiser votre appareil

Hebt u PROBLEMEN met de bediening?

Stel het apparaat terug

Zie de pagina met de paragraaf Het apparaat terugstellen

JVC

VICTOR COMPANY OF JAPAN, LIMITED



EN, GE, FR, NL



0302MNMDWJEIN